



USER MANUAL

Electronic Chart System (ECS)
NES-1000

Modify Record

No.	Modify by	Date	Paragraph	Revision	Reason
1	Q/A	2016/12/14		01	First edition
2	Q/A	2018/5/21		02	Generally modified

Table of Contents

1. Outlines	1
2. Product Description	2
2.1 Processor Unit.....	2
2.2 Monitor.....	2
2.3 Track ball	2
2.4 Wind Sensor.....	3
2.5 Display Screens.....	3
2.5.1 Screen Description	3
2.5.2 Icons Description	5
2.6 Power On/Off.....	7
3. Technical Specifications	7
4. Operations.....	8
4.1 Zoom in and out.....	8
4.2 Display Mode.....	8
4.2.1 Direction Mode	8
4.2.2 Move Mode.....	9
4.2.3 Color Mode.....	11
4.3 Chart Display	13
4.3.1 Chart Information.....	13
4.4 Measurement Tools	15
4.4.1 Distance Measurement.....	15
4.4.2 Position Calculation	16
4.4.3 CPA/TCPA	16
4.4.4 VRM	17
4.4.5 EBL.....	17
4.5 Chart Management.....	18
4.5.1 Load Chart to Database	19
4.5.2 Unload Chart from Database.....	19
4.6 Chart Plot.....	19
4.7 Navigation Management.....	19
4.7.1 Trace Display.....	19
4.7.2 Navigation Record	20
4.8 Route Management	22
4.9 System Settings.....	22
4.9.1 Communication Setting	23
4.9.2 AIS Data Setting	23
4.9.3 Alarm Setting	24
4.9.4 GPS Data Setting	24
4.9.5 System Setting	24
4.10 Sound and Alarm Setting	25

4.11 Fencing Area Setting.....	25
4.12 Short Message	26
4.13 Full Screen Display.....	26
4.14 Quit the System	27
5. Installation.....	27
5.1 Equipment Installation	27
5.1.1 Processor Unit Installation.....	27
5.1.2 Monitor Installation	27
5.1.3 Power Supply	27
5.1.4 Wind Sensor.....	27
5.2 Connection to External Devices.....	28
Appendix Installation Drawings.....	29

1. Outlines

The system consists of Monitor, Processor Unit, Track Ball and Wind sensor.

- **Conforms with IHO S52 electronic chart display standard**
Use S-57 format chart as source charts. The display conforms to IHO S52 standards.
- **Chart display zooming**
The chart can be displayed by zooming in or out.
- **AIS targets displayed**
AIS targets are displayed in real time.
- **COG, SOG and HDT displayed**
The current COG, SOG and HDT are displayed.
- **Quick search for vessels**
Quickly locate the vessels to check the detailed data for the vessel by click the displayed targets.
- **CPA/TCPA Calculation**
A tool is provide to calculate CPA/TCPA between own vessel and a target vessel.
- **Route Design**
Routes can be designed, modified and deleted.

2. Product Description

2.1 Processor Unit



2.2 Monitor



2.3 Track ball



2.4 Wind Sensor



2.5 Display Screens

2.5.1 Screen Description

Chart Window

Chart Window (indicated by a blue arrow pointing to the chart area)

Current Time (indicated by a blue arrow pointing to 2014/04/03 10:38:03)

Own Data (indicated by a blue arrow pointing to 31°12.550'N, 121°37.223'E, 0.6kt, 34.3°)

Wind (indicated by a blue arrow pointing to Invalid 0.0°(R) 0.0Kt)

Cursor (indicated by a blue arrow pointing to CurRoute: jytjlrh)

Chart Information (indicated by a blue arrow pointing to XTE: 4.51NM, NextWPT RNG: (1396489)2, NextWPT ETA: 0 H 0 M)

Tools (indicated by a blue arrow pointing to the grid of icons)

Alarm Status (indicated by a blue arrow pointing to AIS COUNT: 153, AIS LIST, ALARM buttons)

Software Version (indicated by a blue arrow pointing to ECS-7019MT, S/W : V1.2)

Bright mode interface, for example

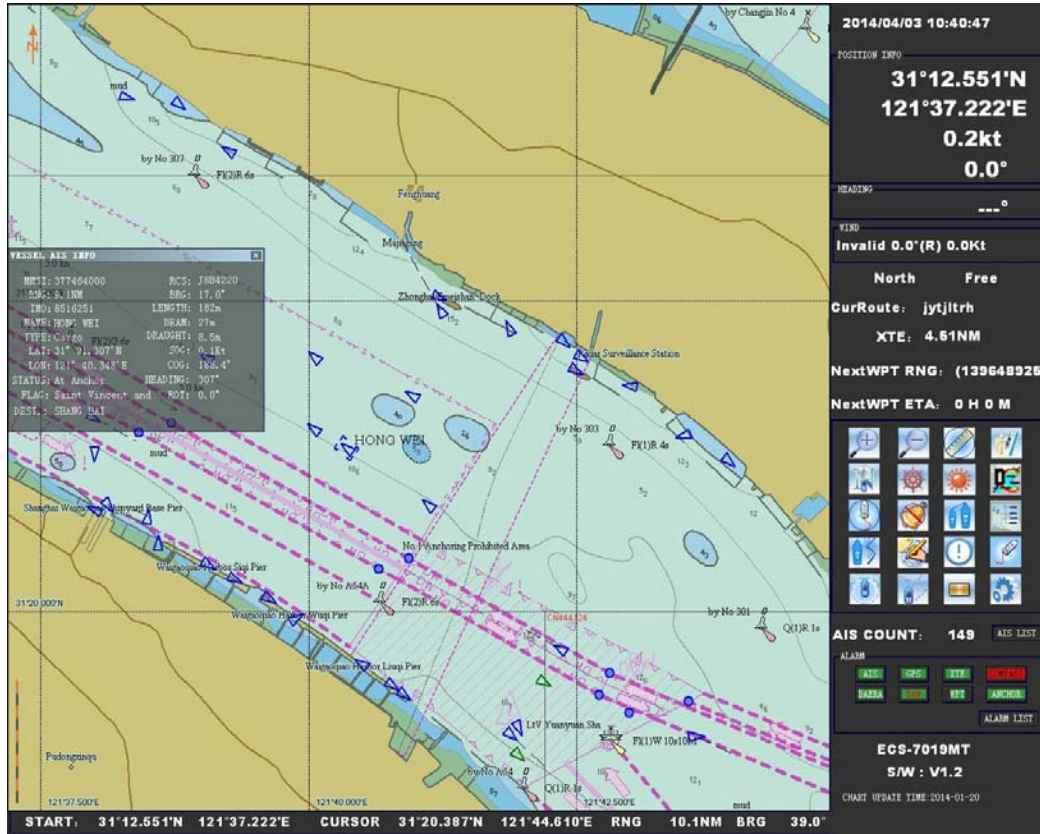

Locate an AIS target

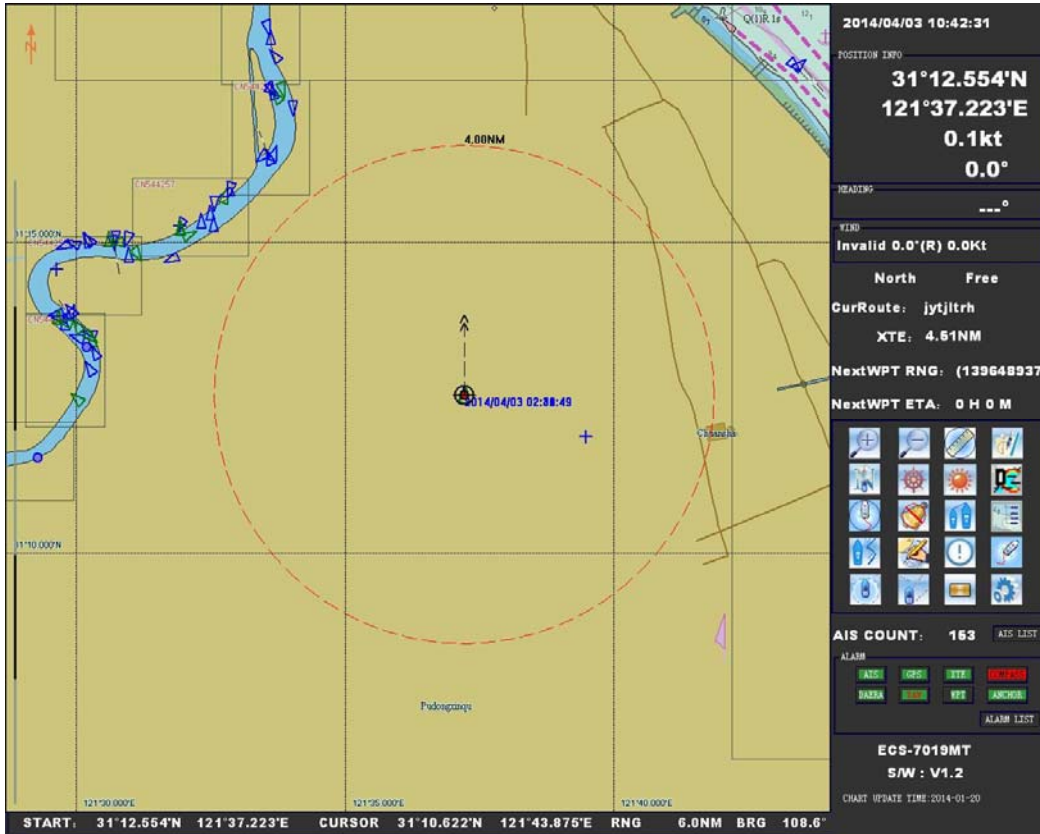

Own vessel

2.5.1.1 Chart Window

Basic functions:

- Display own position
- Mark a specific place and build up a navigation dot
- Design a route and save the trace
- Monitor the surrounding vessel while AIS is connected

2.5.1.2 Data Area

























In Data Area, there are current time, own vessel's data (GPS position, COG, SOG and heading), cursor data (GPS position, distance and bearing) and alarm event list (time, source, course and status).



















































Note: The alarm status will not stop flashing until the alarm is confirmed by click the flashing button.

2.5.1.3 Tool Bar

Tool bar contains operation buttons which are described in 2.5.2.

2.5.2 Icons Description

ICONS			Name	Function
bright	evening	night		
			Zoom out	Enlarge the chart
			Zoom in	Decrease the chart
			Measurement	Measure the distance between two points
			Calculation	Calculate the position, distance and bearing
			Chart management	Load, unload and update the charts
			Direction mode	Set the direction mode
			Move mode	Set the move mode
			Color control	Set the color mode

ICONS			Name	Function
bright	evening	night		
			Display control	Set the chart display information
			System setting	Set the system parameters
			Connection	Reserved for future use
			Trace display	Set the trace display
			Target filter	Filter the AIS targets
			Alarm sound	Enable or mute the alarm sound
			CPA/TCPA	Calculate the CPA/TCPA
			Route management	Add, call, screen or delete a route
			Route editor	Edit the current route
			Chart plotter	Add or delete a temporary mark on chart, including a dot or line
			Fencing area	Set a fencing area on the chart
			Navigation record	Record and playback the navigation data of own vessel
			VRM	Edit VRM
			EBL	Edit EBL
			Short message	Receive an AIS message
			Full screen display	Display in full screen
			Power off	Power off

2.6 Power On/Off

- **Power on**
Press the power switch on monitor panel to start the ECS software.
- **Power off**
Press the power switch again to power off the ECS.

3. Technical Specifications

- **Monitor**

Resolution	1280 x 1024
Color	32 bits, TFT
Power supply	DC24V
Dimension	≥(17") 435 x 340 x 60mm (W x H x D)
Weight	Abt 6kg
- **Processor Unit**

Interface	RS232 1EA
	RS422 1EA
	RS422 3EA (RX only)
	USB 2EA
Format	Conform with IEC61162-1, -2
	Baud rate 4800~115200bps
Input power	DC24V
Dimension	174 x 81 x 200mm (W x H x D)
Weight	Abt 2kg
- **S/W**



O/S	Window XP
Operation	Track ball and softkeys
Chart update	USB
- **Monitoring**

plotter	Own position, trace
AIS targets	300
AIS target	Class A, Class B, AtoN AIS, AIS base station
AIS alarm	CPA/TCPA
- **Wind Sensor**

Range	Wind direction 0~360°
	Wind velocity 0~60 m/s
Accuracy	Wind direction ±5° ,
	Wind velocity ±(0.5+ V×5%) m/s

4. Operations

4.1 Zoom in and out

Press  to zoom out the chart. Press  to zoom in the chart.

When the chart is zoomed out as largest or zoom in as smallest, a warning will be prompted. Click the confirmation button to escape.

4.2 Display Mode

4.2.1 Direction Mode

Press  to select NORTH UP or HEADING UP mode.

- **HEADING UP:** chart will rotate to keep heading up while sailing.

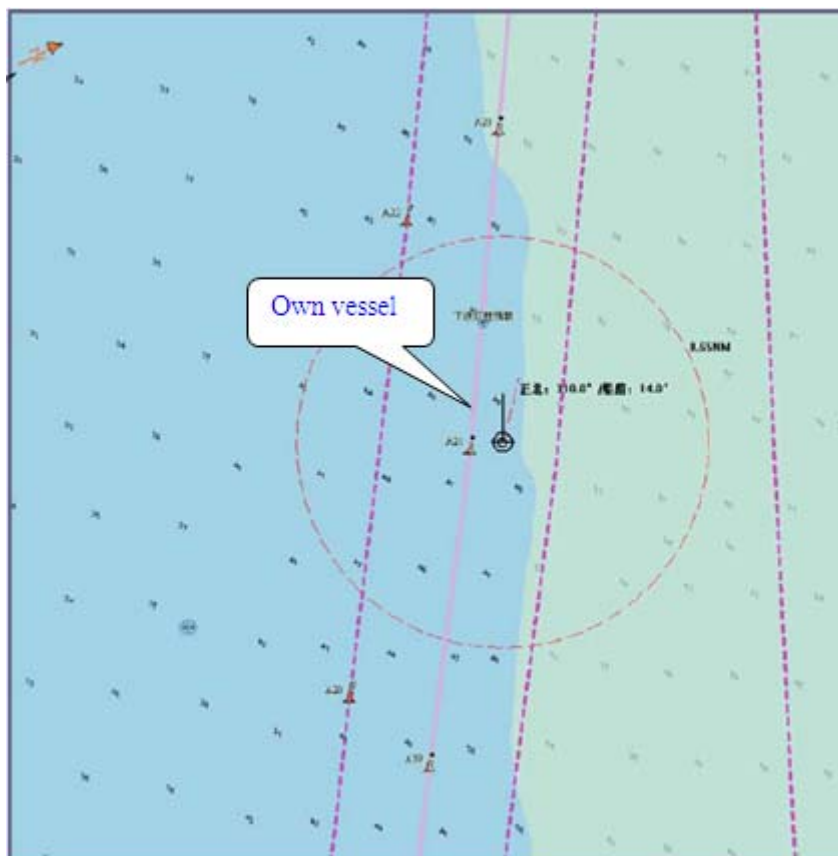

- **NORTH UP:** the chart will keep unchanged as north up.

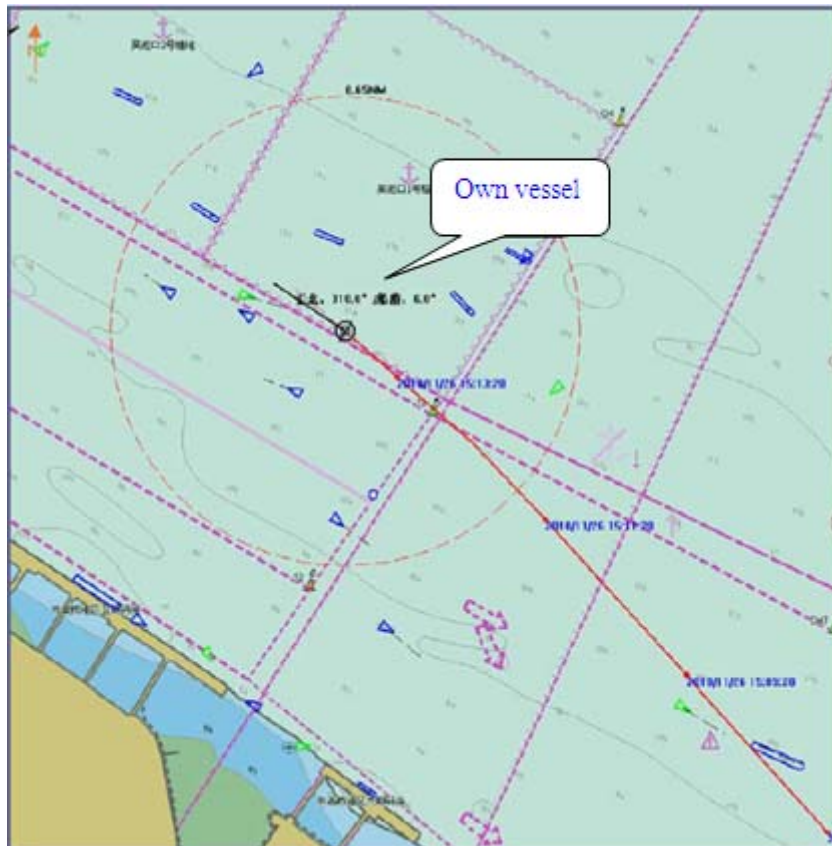

4.2.2 Move Mode

Click  to select FREE MODE, LOCK MODE or CENTRE-BAIS MODE.

- **FREE MODE:** The chart can be dragged freely.



- **LOCK MODE:** The chart is locked as own vessel is always in the centre of screen.

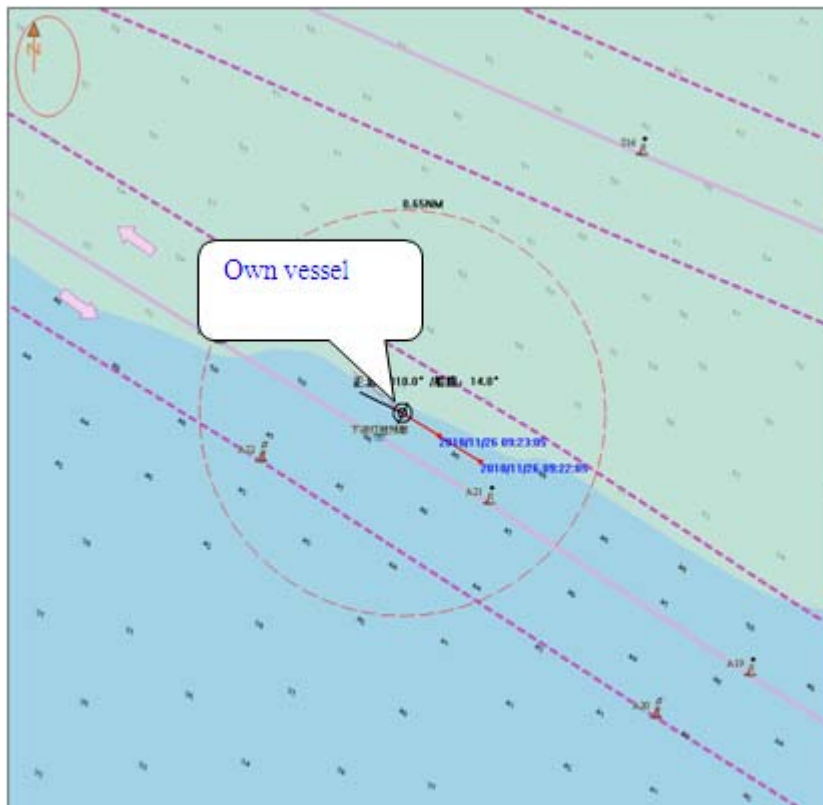

- **CENTRE SHIFT:** While the vessel is moving, chart will keep still until the vessel moves to 75% shift from the centre of screen, when the chart is refreshed as own vessel returns to centre of screen.

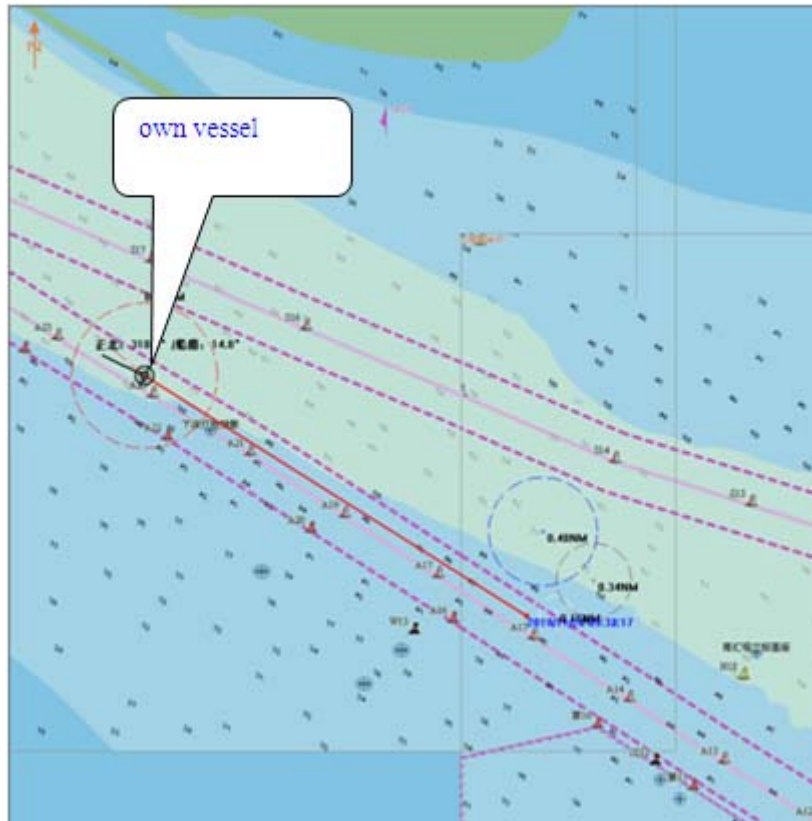

4.2.3 Color Mode

Click  to select BRIGHT MODE, DUST MODE or NIGHT MODE.

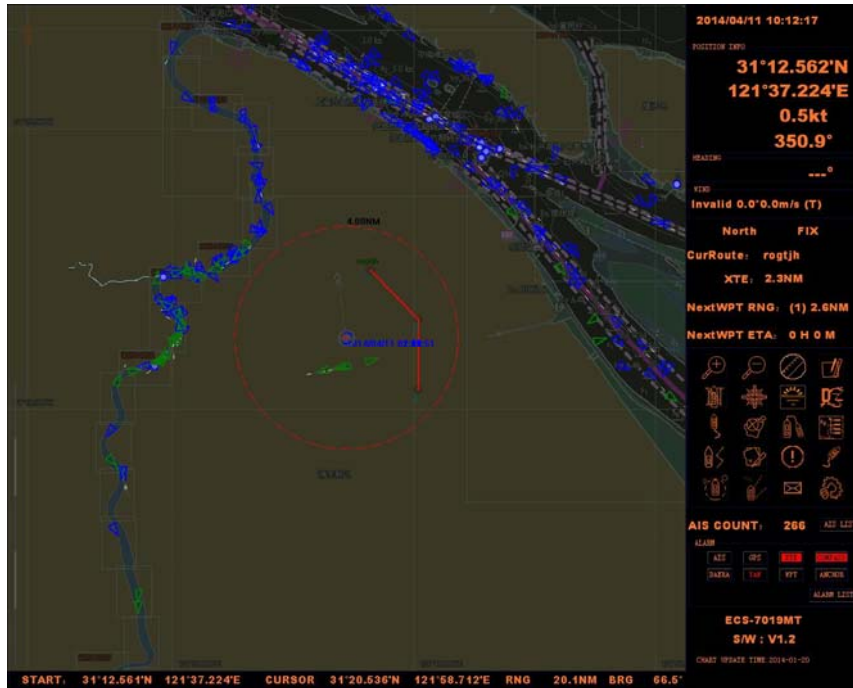

DUST MODE

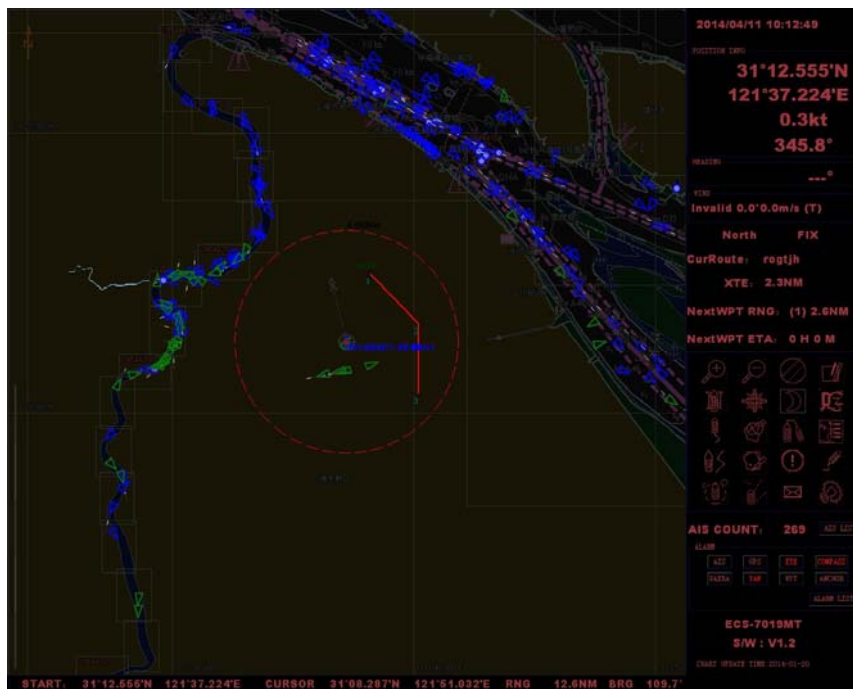

NIGHT MODE

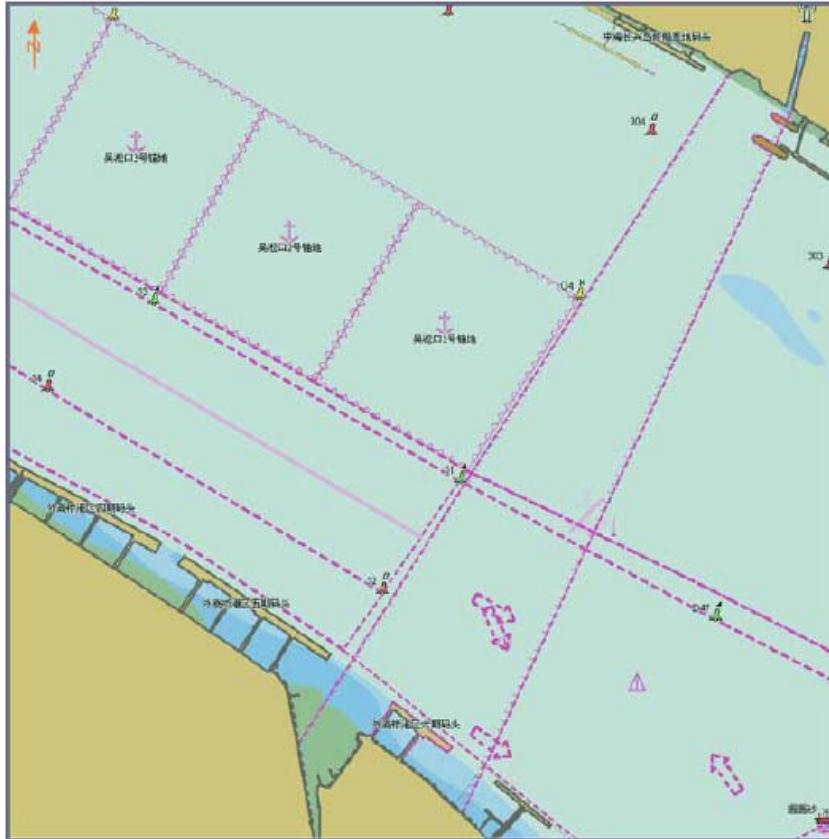

- **DETAIL DISPLAY:** Display the detailed display information defined in IHO S52.

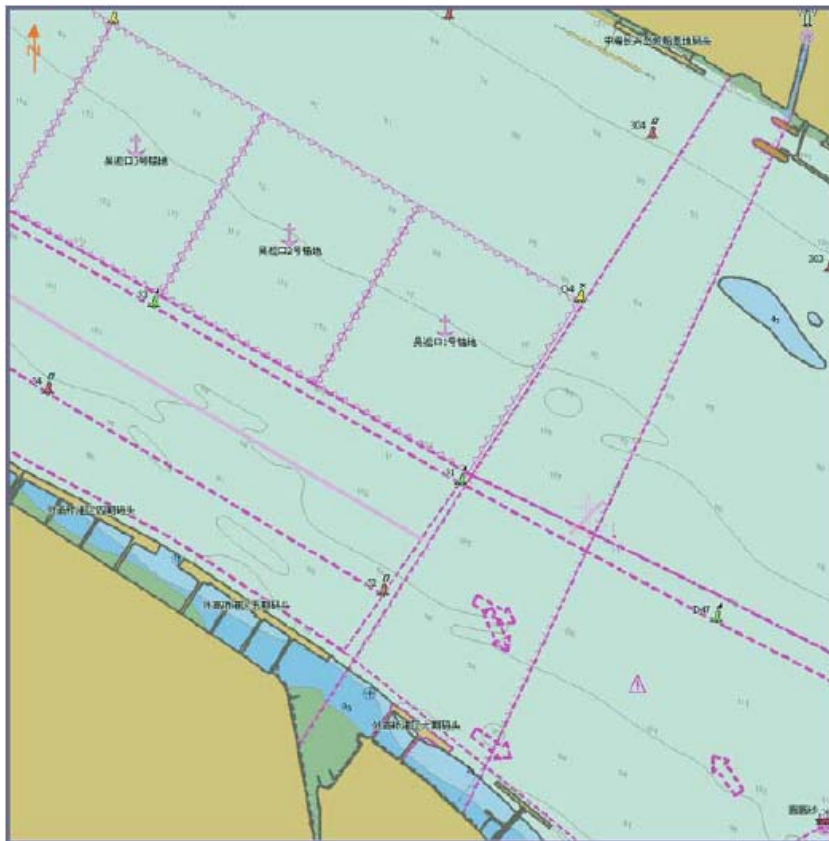

4.4 Measurement Tools

4.4.1 Distance Measurement

Click  to measure the distance between two points or between own vessel and one spot on chart.



Measure the distance between two points

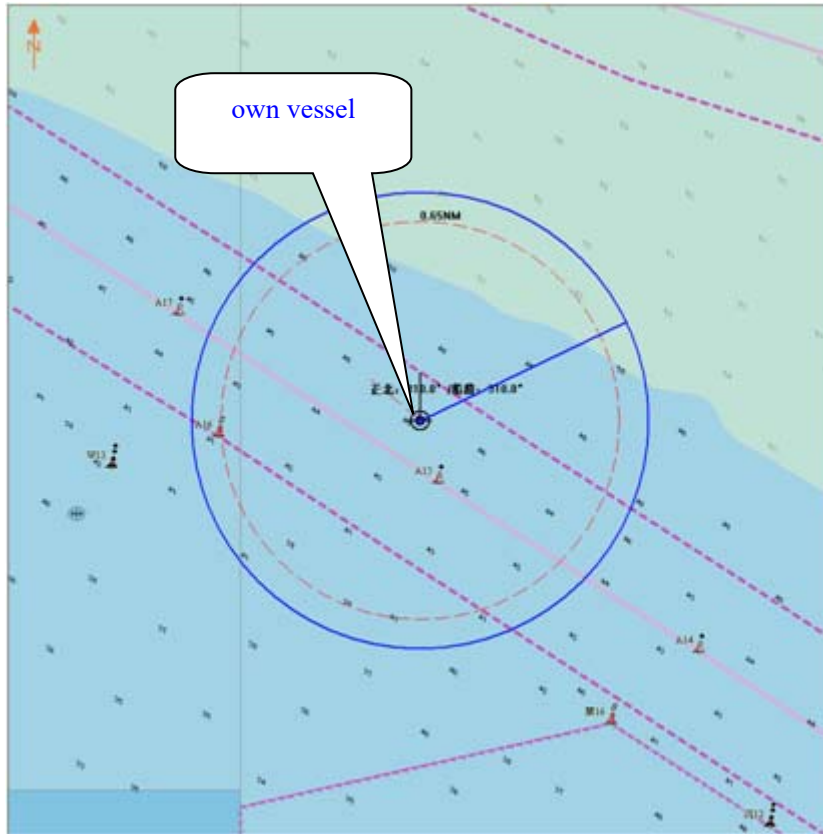

Measure the distance own vessel and a place

4.4.2 Position Calculation

Click  to activate POSITION CALCULATION tool.

- Locate the screen centre: to move the chart to the centre of screen as inputting position.
- Calculate the distance between two dots: to calculate the distance and bearing by inputting two positions.
- Locate the second position: to locate the second position by input the first position and distance/bearing.

Note: The soft keyboard can be used to key in the figures.

4.4.3 CPA/TCPA

Click  to calculate CPA/TCPA.

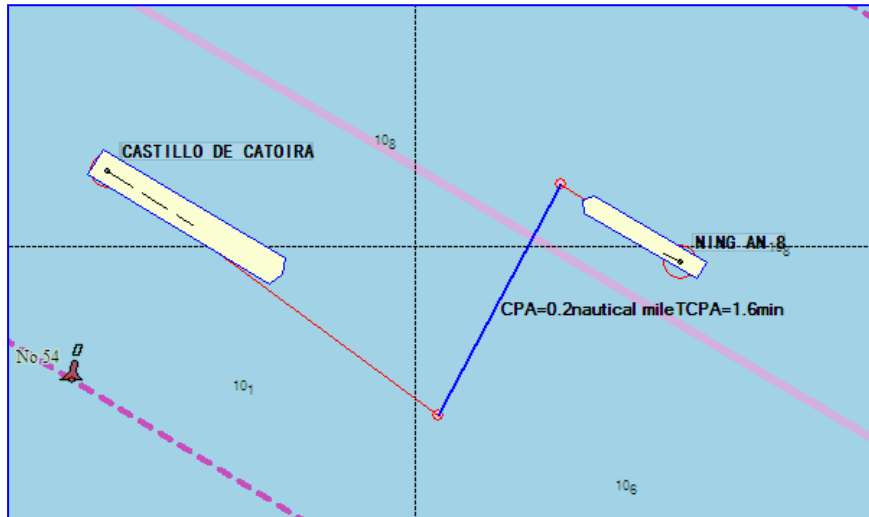

4.4.4 VRM

Click  to access VRM tool.

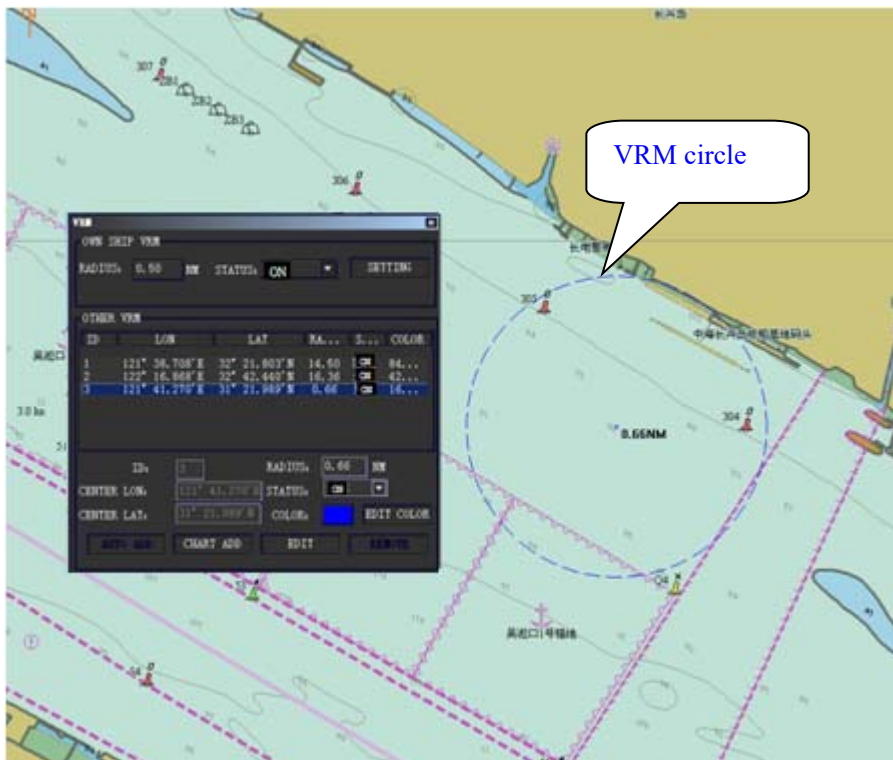

4.4.5 EBL

Click  to access EBL tool.



4.5 Chart Management

Click  to access chart management. The chart list is displayed.

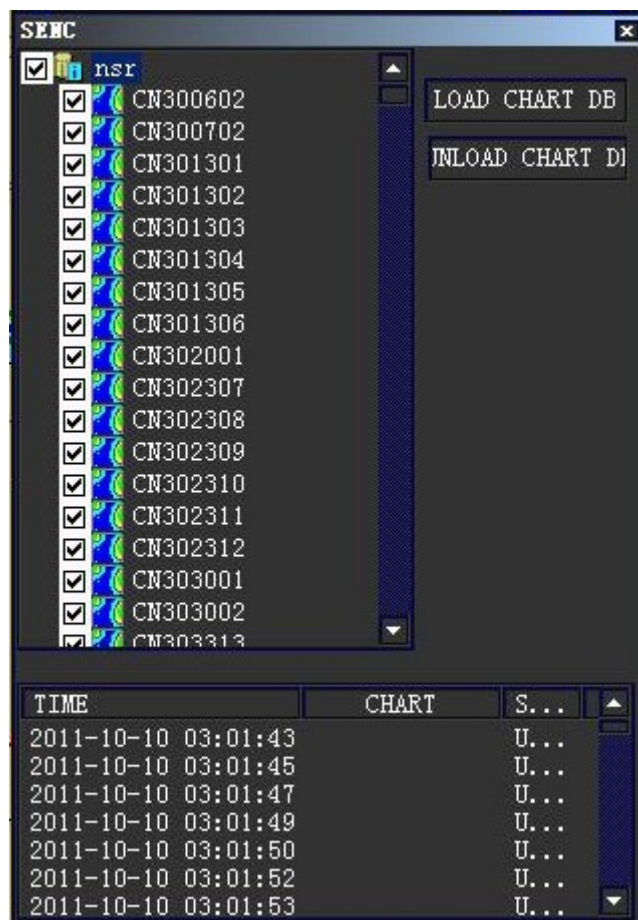

4.5.1 Load Chart to Database

Load the charts into database.

4.5.2 Unload Chart from Database

Delete the charts from the database.

4.6 Chart Plot

Click  to open the chart editor to add or delete marks including dot, line and area.

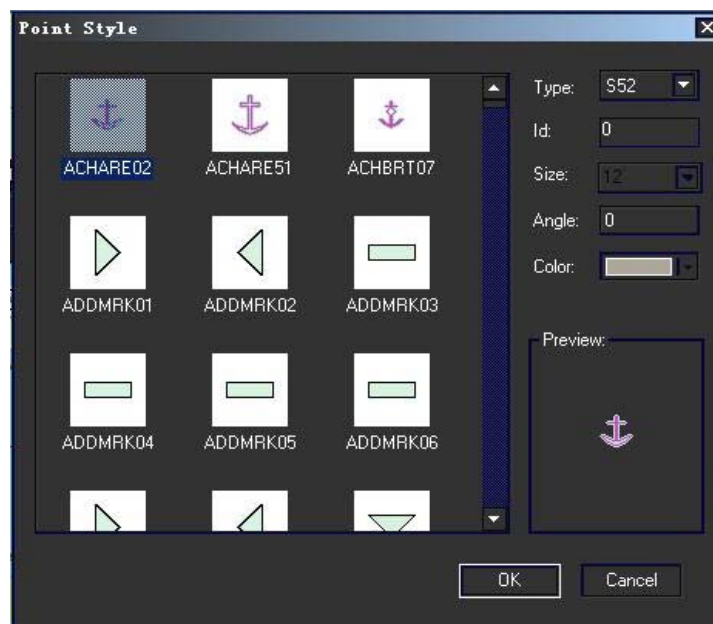
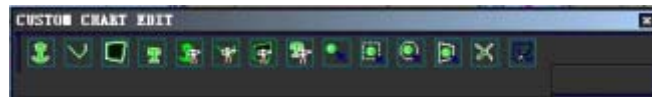

4.7 Navigation Management

4.7.1 Trace Display

Click  to display real-time trace.

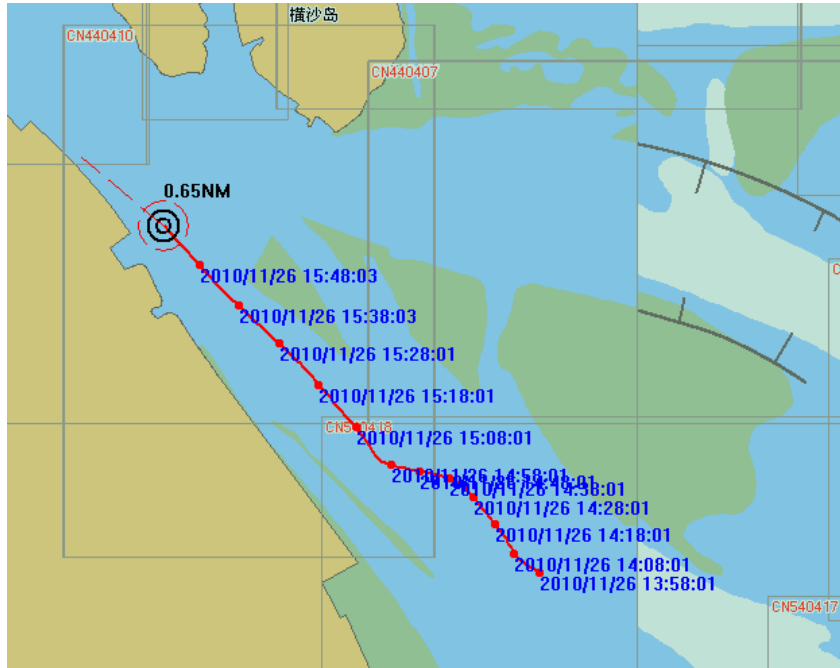

Display the trace of two hours

4.7.2 Navigation Record

Click  to select HISTORY TRACE or INDEPENDENT TRACE.

4.7.2.1 History Trace

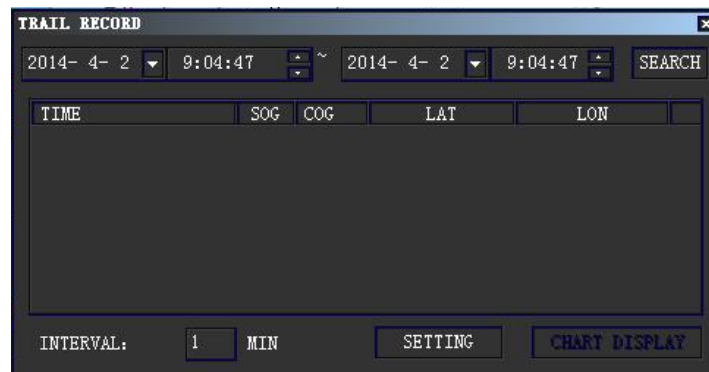

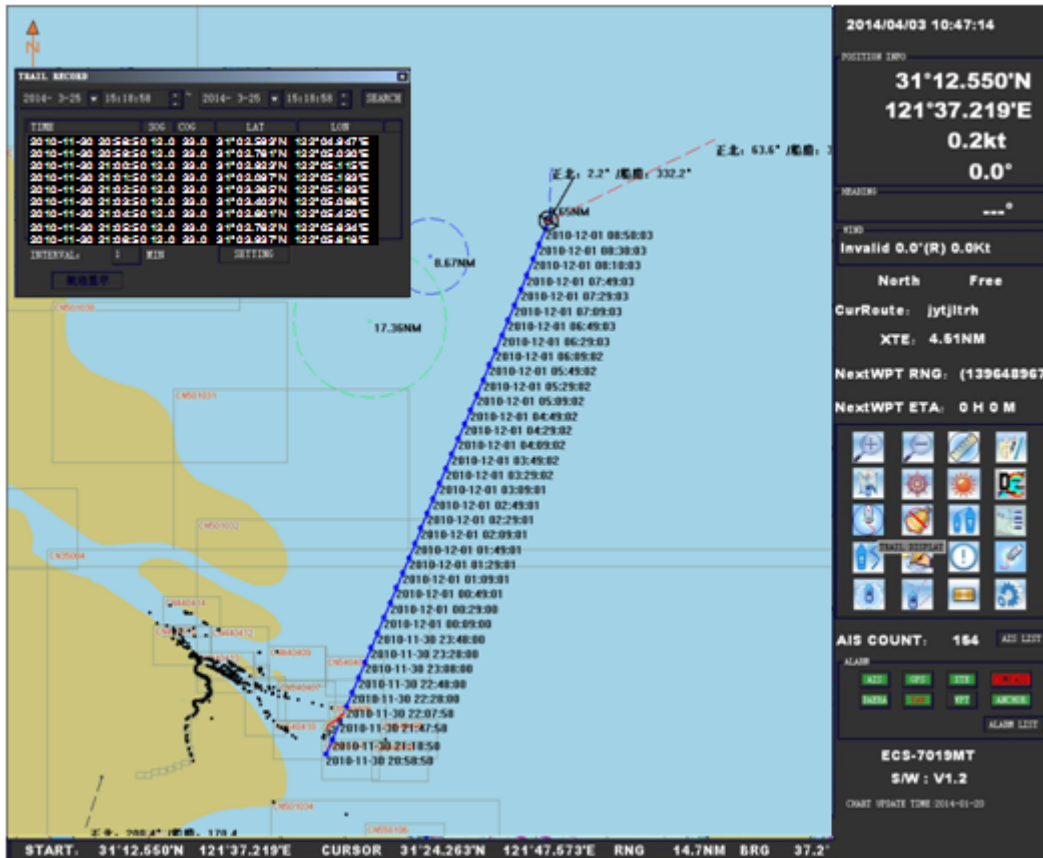

4.8 Route Management

Click  to open ROUTE EDITOR.

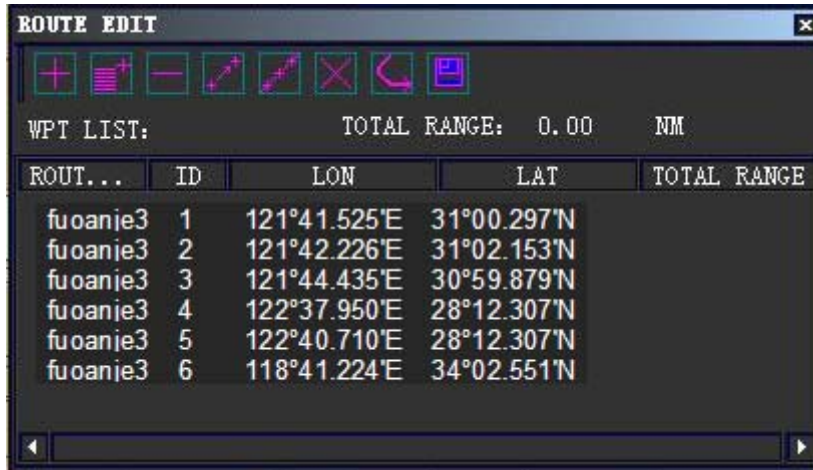

The screenshot shows a window titled "ROUTE EDIT" with a toolbar and a table. The toolbar contains icons for adding, deleting, moving, and saving route points. The table below shows the current route points.

ROUT...	ID	LON	LAT	TOTAL RANGE
fu oanje3	1	121°41.525'E	31°00.297'N	
fu oanje3	2	121°42.226'E	31°02.153'N	
fu oanje3	3	121°44.435'E	30°59.879'N	
fu oanje3	4	122°37.950'E	28°12.307'N	
fu oanje3	5	122°40.710'E	28°12.307'N	
fu oanje3	6	118°41.224'E	34°02.551'N	



: add a route dot.



: add a route dot from dot list.



: delete a route dot.



: move a route dot.



: insert a route dot.



: delete all route dots.



: revert all route dots.



: save a route.

4.9 System Settings

Click  for system setting.

4.9.1 Communication Setting

Set the AIS communication port.

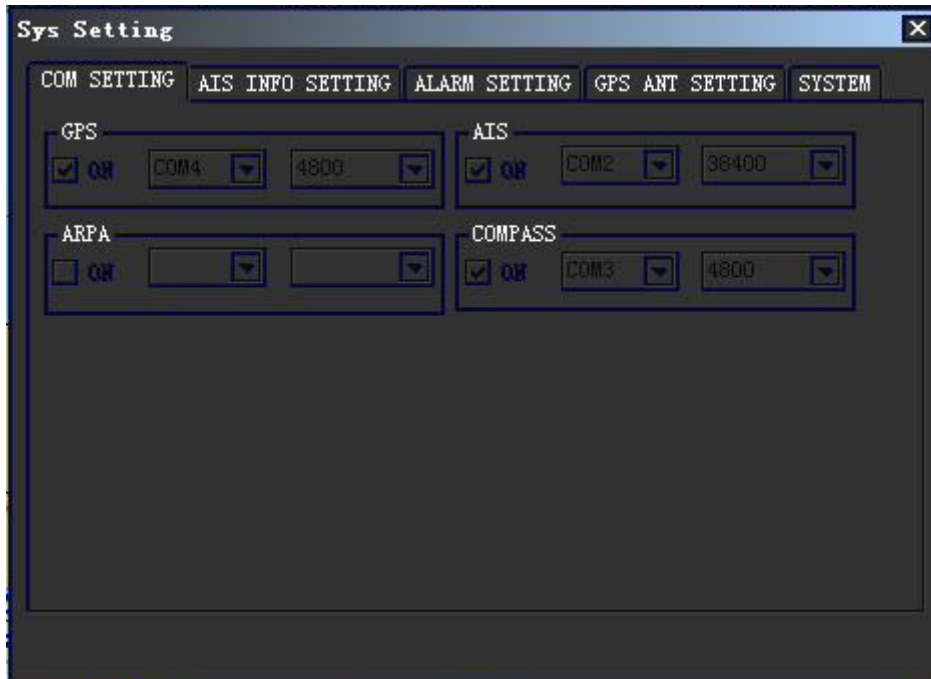

4.9.2 AIS Data Setting

Set the connected AIS with static data. It may be ignored if an existing AIS is connected.

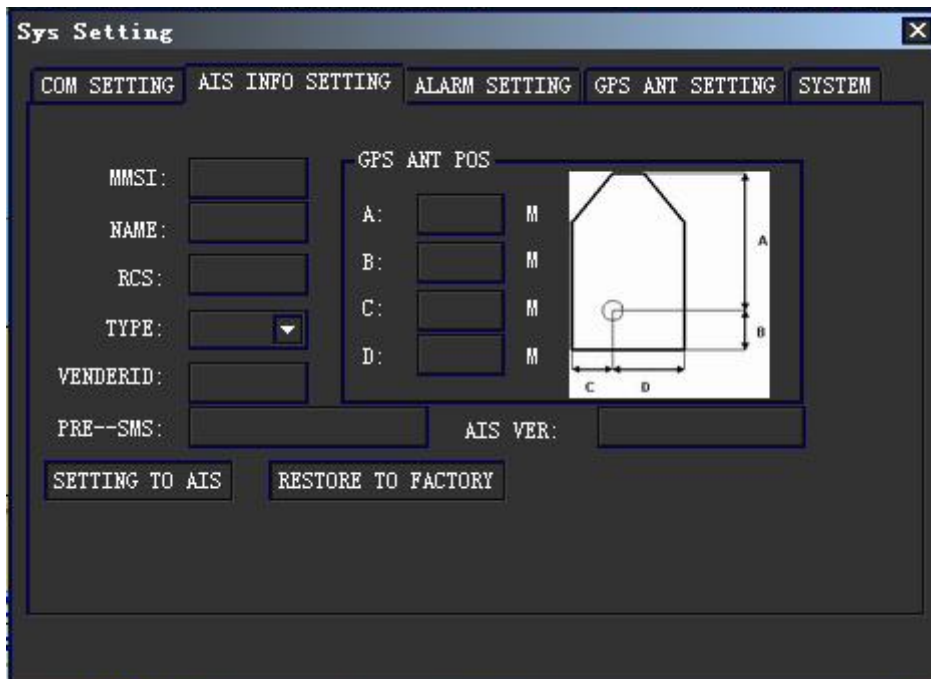

4.9.3 Alarm Setting

Set the alarm conditions.

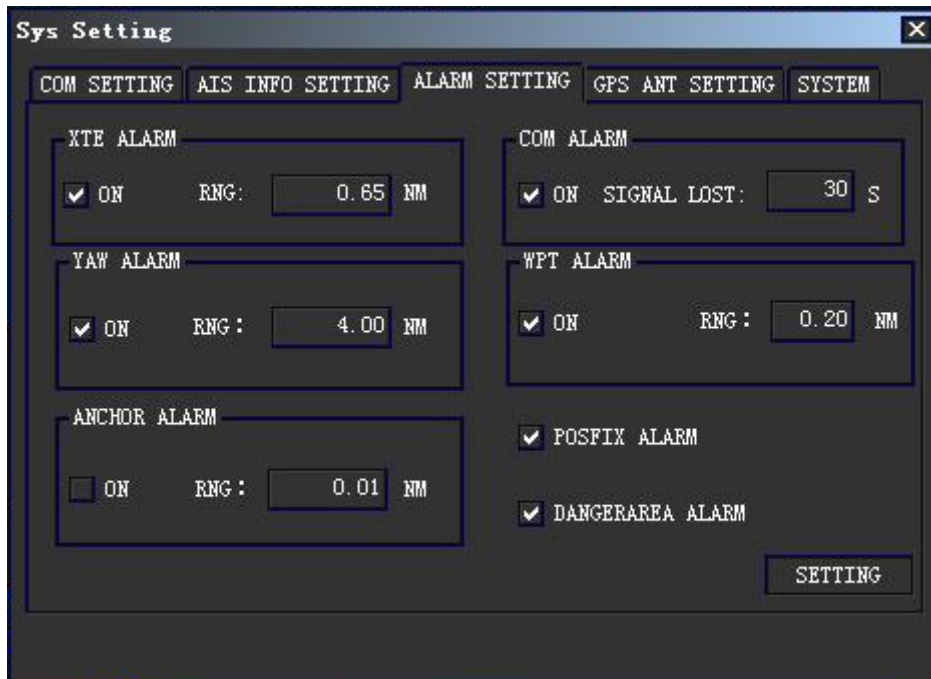

4.9.4 GPS Data Setting

Set the CCRP with location of GPS antenna.

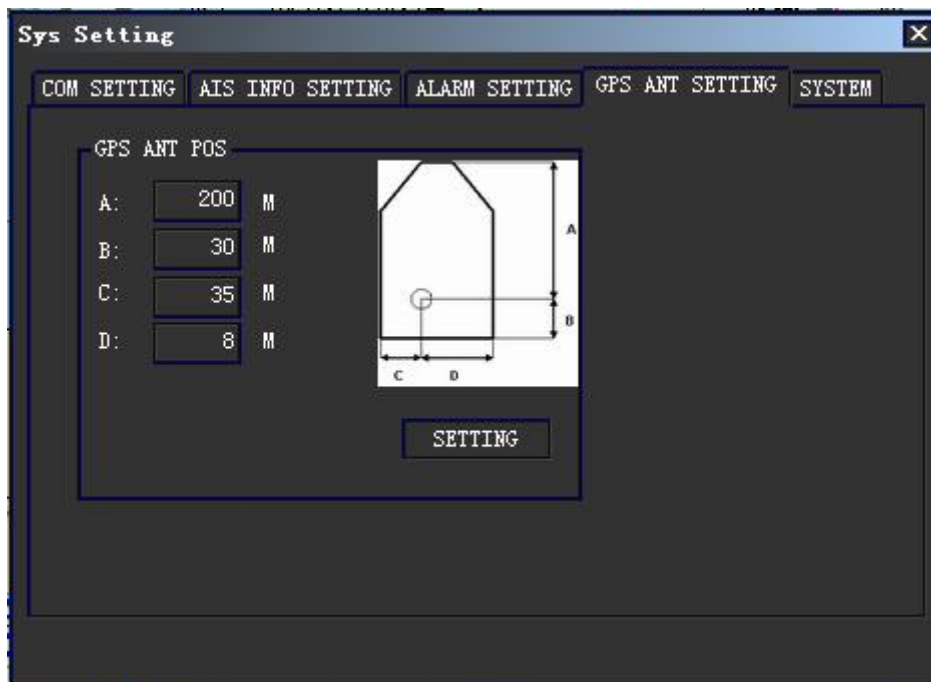



4.9.5 System Setting

In System Setting, there are three items: Time Zone, Wind Unit and Wind Mode.





4.10 Sound and Alarm Setting

Open or close the alarm sound.  means the alarm sound is muted.  means the alarm sound is enabled.

4.11 Fencing Area Setting

Click  to open FENCING AREA SETTING.

: add a fencing area.

: delete a selected area.

: select a fencing area.

: save a fencing area.

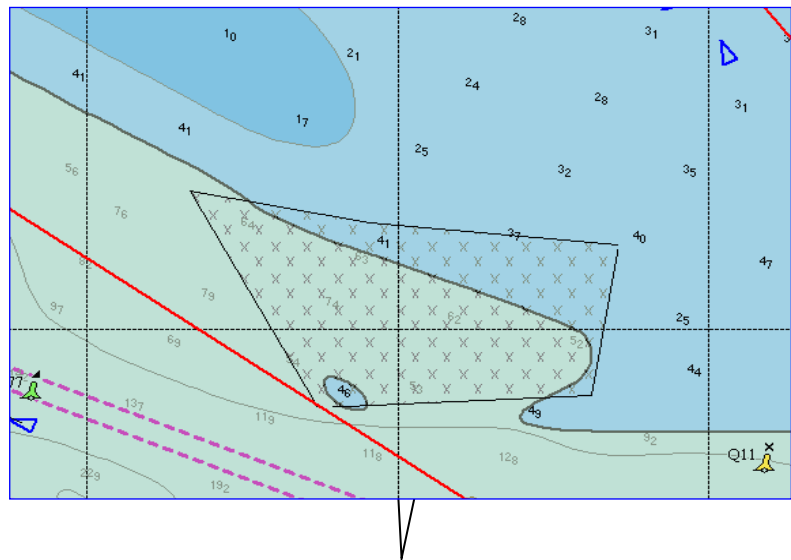

4.12 Short Message

Click  to open SHORT MESSAGE window.

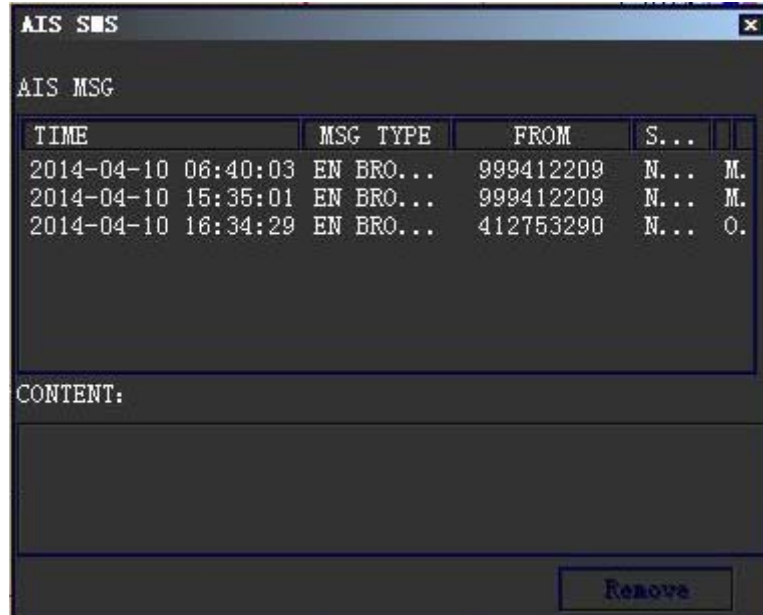

4.13 Full Screen Display

Click  to display in full screen by hiding tool bar.

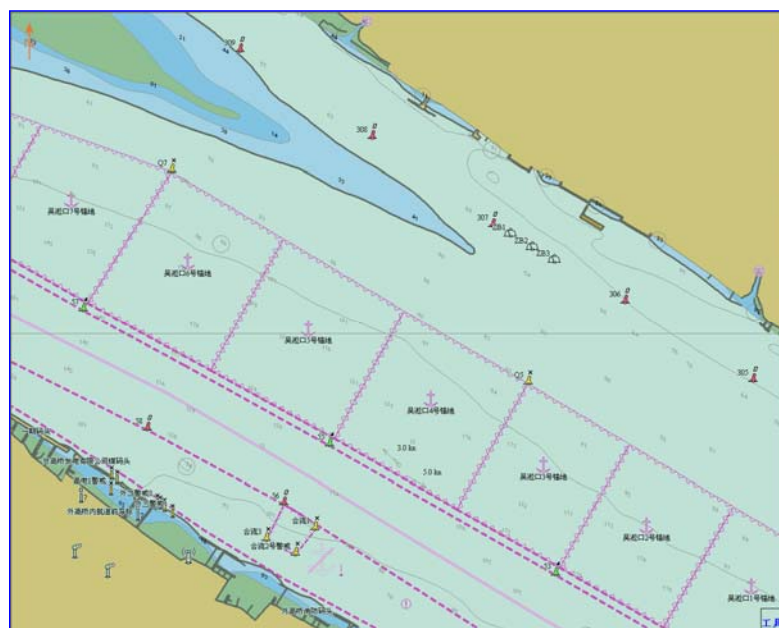

4.14 Quit the System

Click  to quit the system.

5. Installation

5.1 Equipment Installation

5.1.1 Processor Unit Installation

The processor unit can be installed as desk type or wall type.

5.1.2 Monitor Installation

The display unit can be installed in three ways: flush mount, desk type or table type.

5.1.3 Power Supply

The ECS is powered with DC24V.

5.1.4 Wind Sensor

The Wind Sensor should be installed in clear space to avoid any obstacle of wind.

There is an installation base and installation plate supplied together with the Sensor. The steel base should be welded directly or through a support pole on the radar mast. There are five long holes on the round base. The center of one of five holes should be pointed to ship bow. Keep the base horizontal while welding. The installation plate is to protect the Sensor base from cracking while fastened.

There are five round holes on the Sensor base. Fix the Sensor on the mount base with five M10X45 bolts. The long-holes on mount base are used to for the Sensor to adjust until the "N" mark on Sensor base points to bow direction.

5.2 Connection to External Devices

Please refer to the installation drawing for connections.

Appendix Installation Drawings

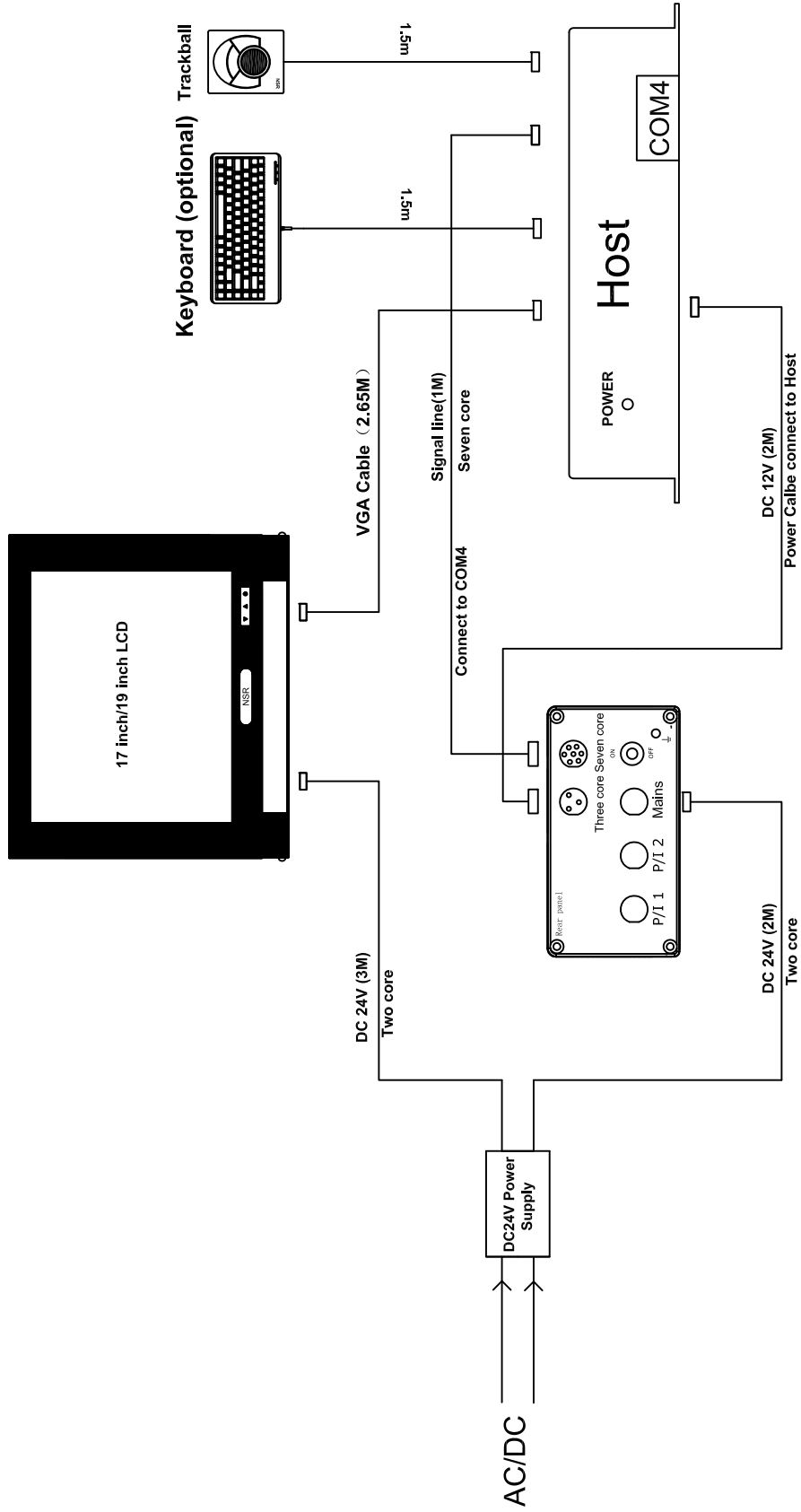

APPLICATION		NES-1000 System connection diagram			
DATE	2020-06-18	ITEM	NES-1000	ECS	SIZE A4
APPROVAL		SCALE	1/5	UNIT/mm	
CHECKED					
DRAWING					
DWG NO.	NES1000-ID-001				

NO.	DATE	REVISION & DESCRIPTION	REVIEWED	CHECKED
			SIGNATURE	



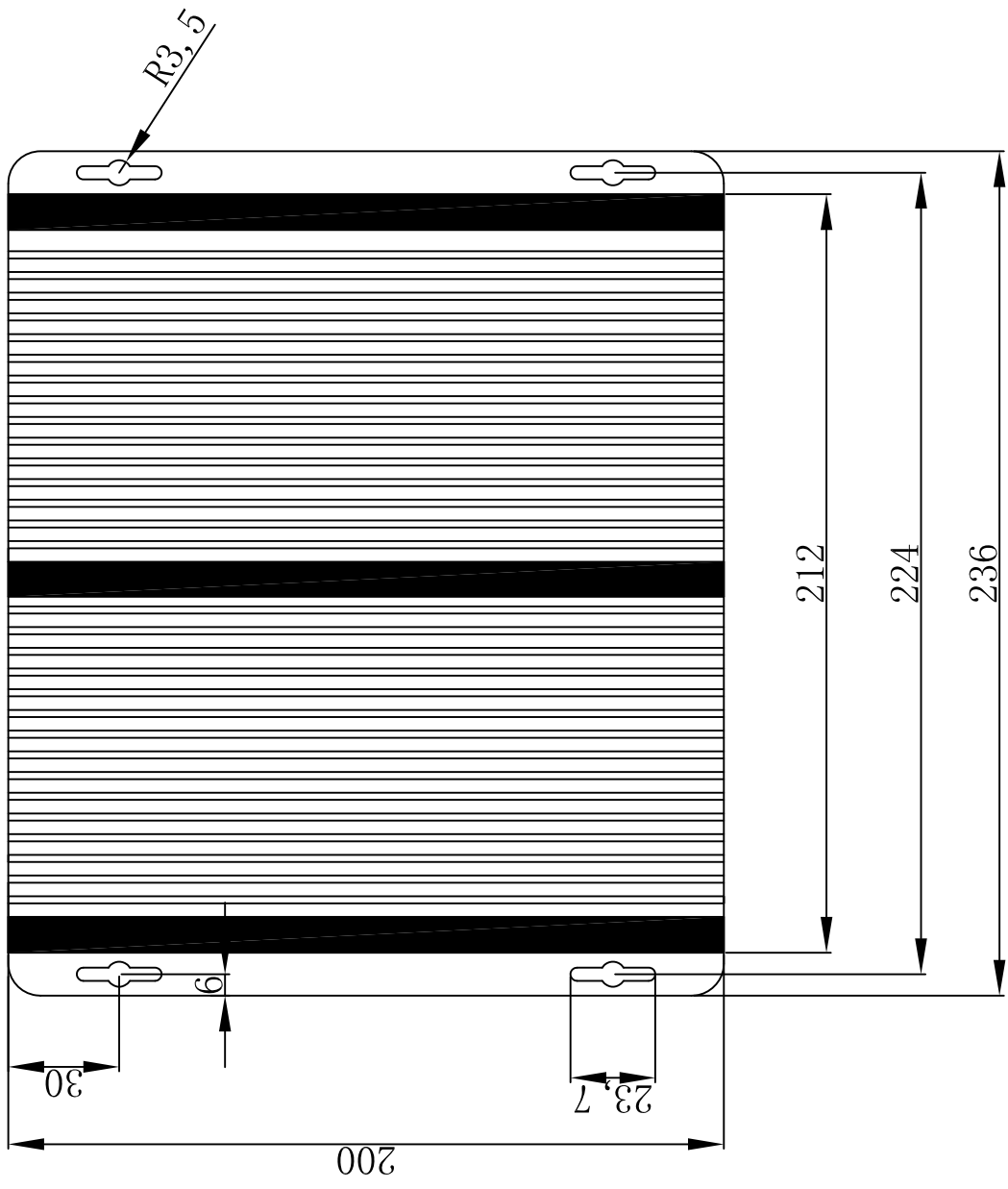

NO.	DATE	REVISION & DESCRIPTION	REVIEWED	CHECKED
△			SIGNATURE	

APPLICATION		NES-1000 Main unit dimension drawing			
DATE	2024-06-18	ITEM	NES-1000		
APPROVAL		SCALE	1:1	UNIT	mm
CHECKED		DESIGNER	VP	DESIGNER	VP
DRAWING		NEW SUNRISE CO., LTD.			
INSTR.	NES1000-ID-002				

Front panel

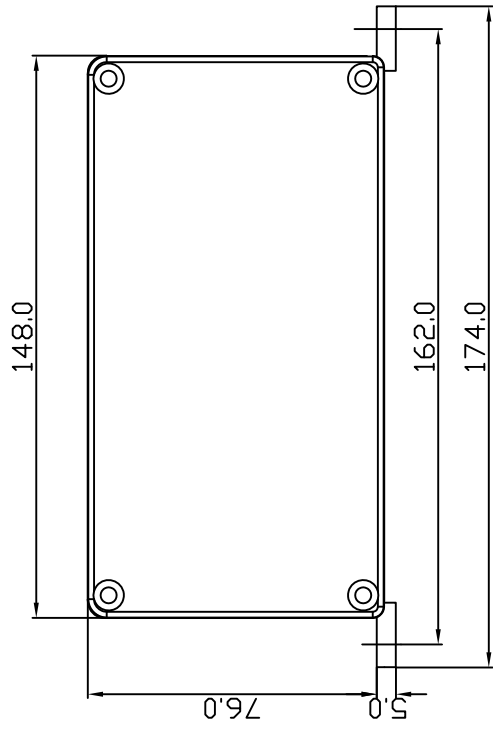

Rear panel

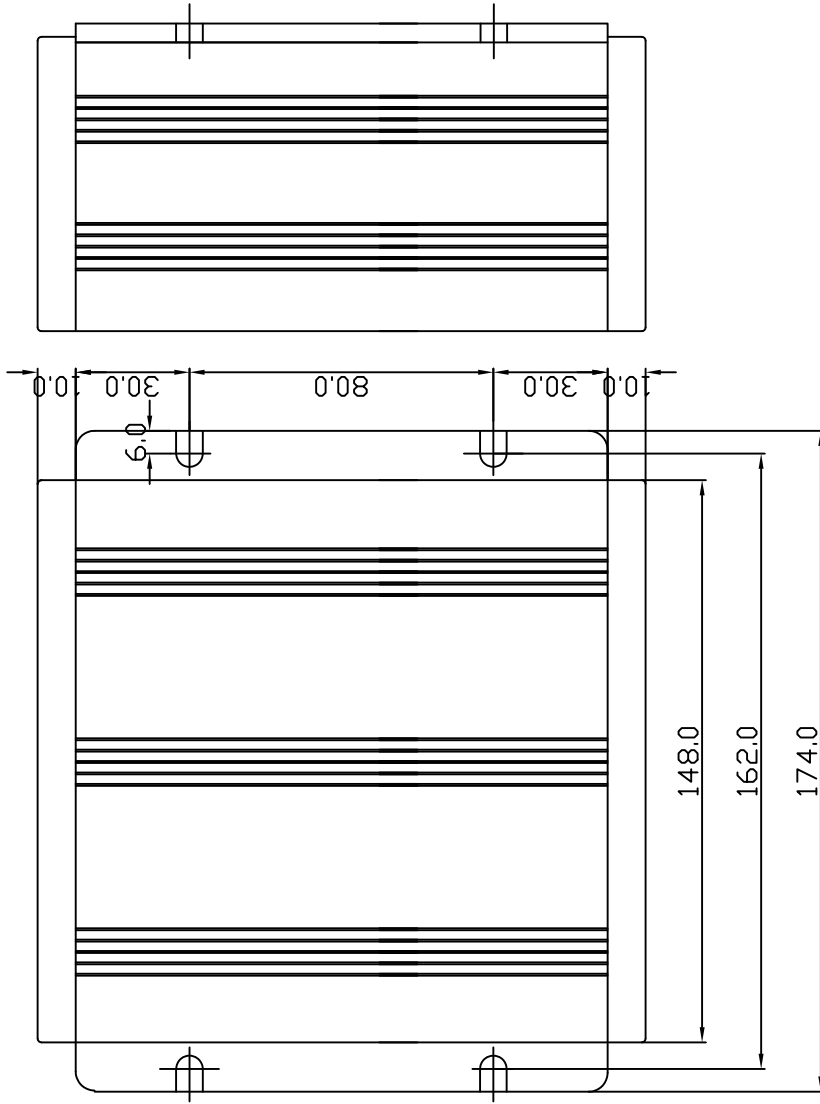
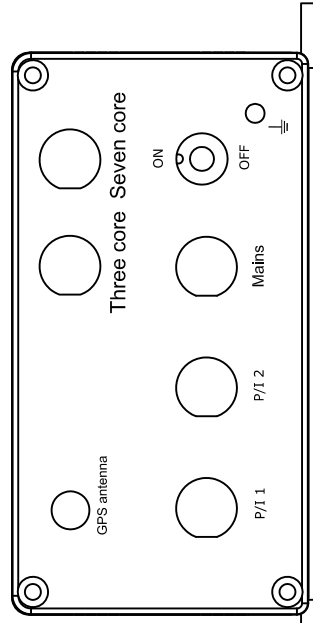

APPLICATION		NES-1000 Dimension drawing of junction box unit			
DATE	2020-06-18	ITEM	NES-1000	ECS	SIZE A4
APPROVAL		SCALE	N/S	UNIT mm	
CHECKED		DRAWING			
DWG NO.	NES1000-ID-003				

NO.	DATE	REVISION & DESCRIPTION	REVIEWED	CHECKED	SIGNATURE

NEW SUNRISE CO., LTD.	
NSR	

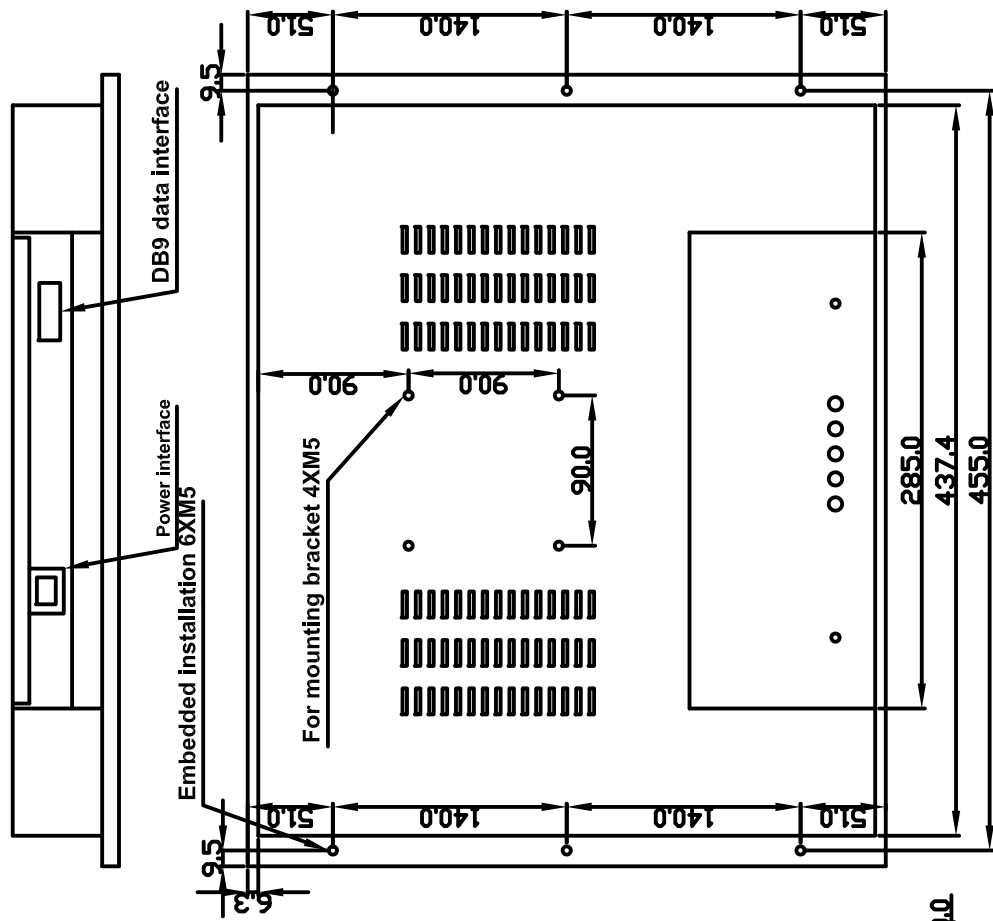

note:
Protection level: IP20
Specifications: 19 inches

APPLICATION		NES-1000 19-inch display size chart			
DATE	2020-06-18	ITEM	NES-1000	ECS	SIZE A4
APPROVAL		SCALE	N/S	UNIT	mm
CHECKED					
DRAWING					
DWG NO.	NES1000-ID-004				

NO.	DATE	REVISION & DESCRIPTION	REVIEWED	CHECKED
			SIGNATURE	



19 inch LCD screen

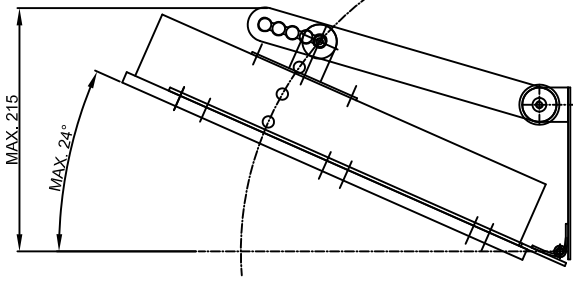
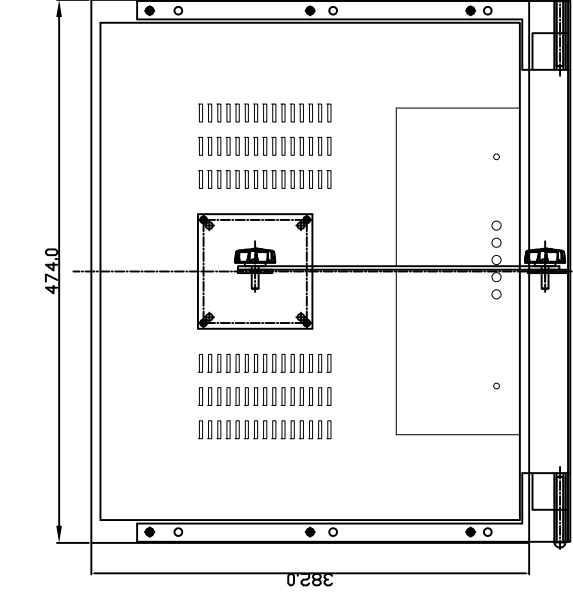
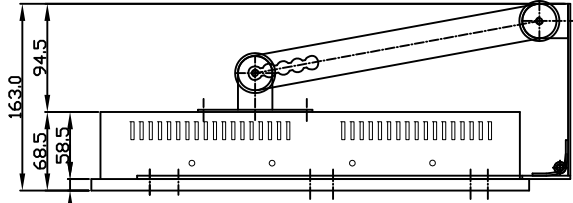
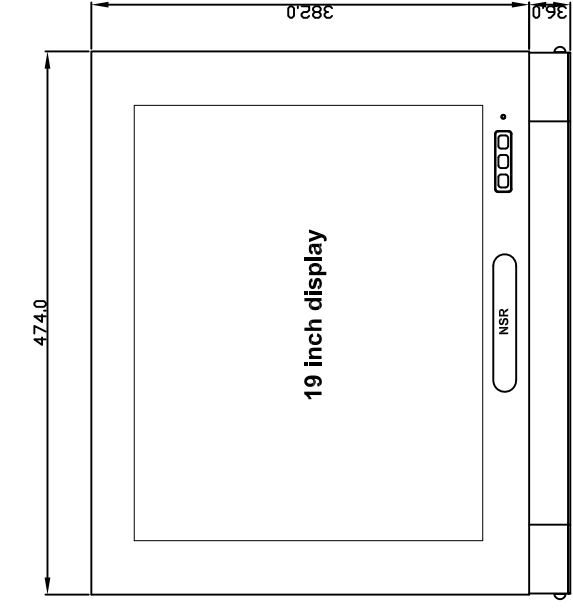
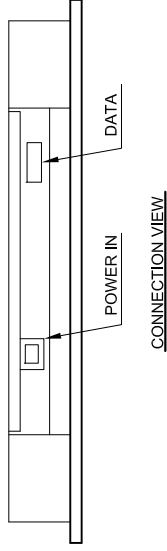
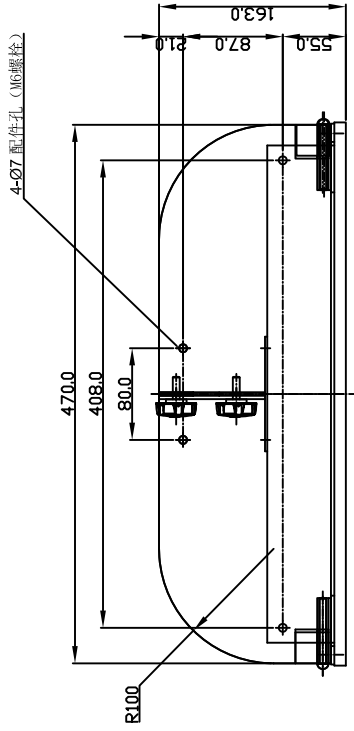

APPLICATION		NES-1000 19-inch vertical installation drawing			
DATE	2020-06-18	ITEM	NES-1000	ECS	SIZE A4
APPROVAL		SCALE	1/3	UNIT/mm	1/3
CHECKED		DRAWING			
DWG NO.	NES1000-ID-005	NEW SUNRISE CO., LTD.			

NO.	DATE	REVISION & DESCRIPTION	REVIEWED	CHECKED	SIGNATURE

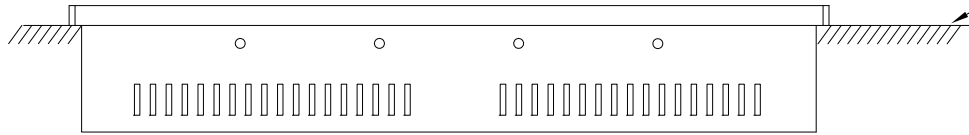

Panel

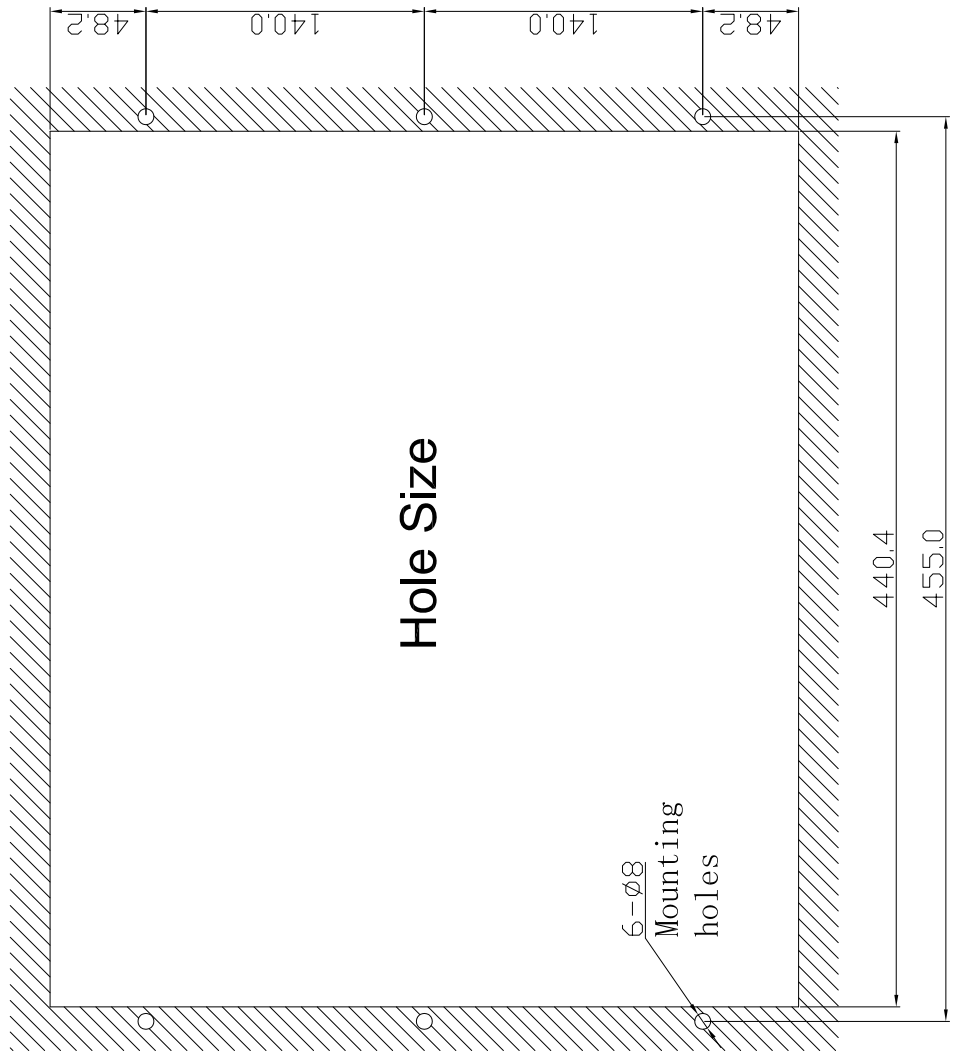

Hole Size

6-∅8
Mounting
holes

440.4
455.0

APPROVAL	DATE	ITEM	SCALE	N/S	UNIT	mm	NES-1000	ECS	SIZE	A4
CHECKED	2020-06-18									
DRAWING										
DWG NO.	NES1000-ID-006									

APPLICATION NES-1000 19-inch vertical installation drawing

NO.	DATE	REVISION & DESCRIPTION	REVIEWED	CHECKED
				SIGNATURE



315.0

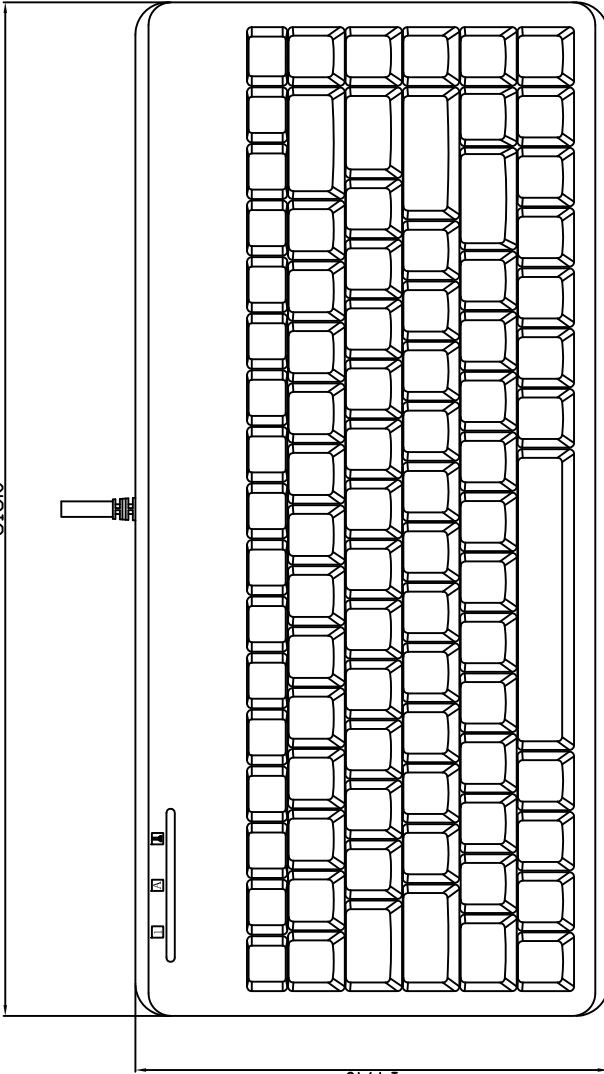

147.0

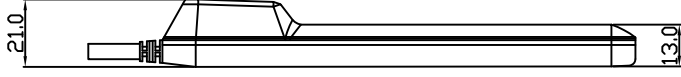

21.0

13.0

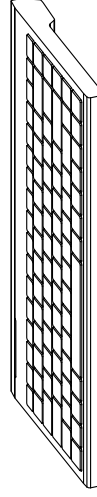
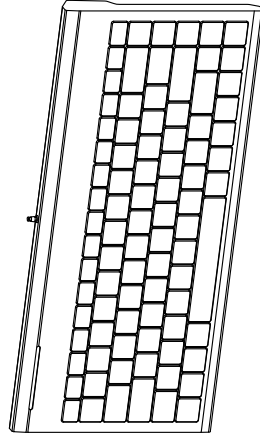

APPLICATION		NES-1000 Keyboard size chart			
DATE	2020-06-18	ITEM	NES-1000	ECS	SIZE A4
APPROVAL		SCALE	N/S	UNIT	mm
CHECKED					
DRAWING					
DWG NO.	NES1000-ID-007				

NO.	DATE	REVISION & DESCRIPTION	CHECKED	SIGNATURE

NEW SUNRISE CO., LTD.

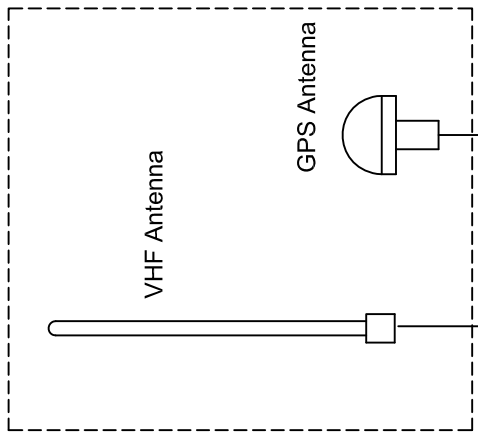
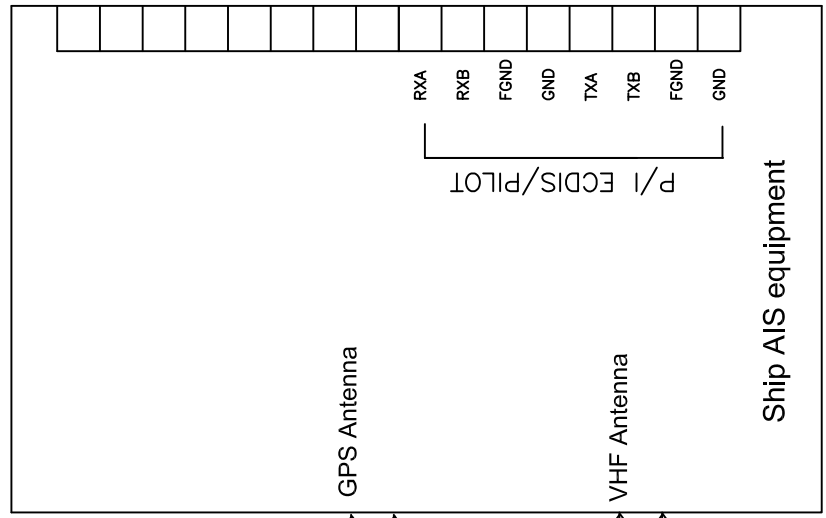
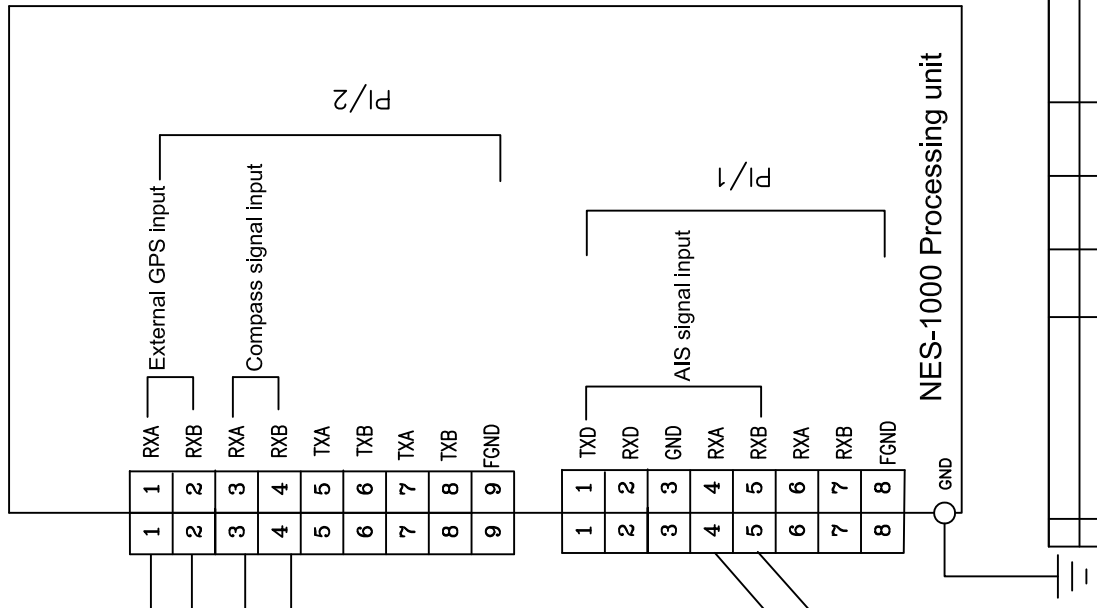

APPLICATION

DATE	2020-06-18	ITEM	NES-1000	ECS	SIZE	A4
APPROVAL		SCALE	1/5	UNIT	mm	
CHECKED						
DRAWING						
DWG NO.	NESS1000-ID-008					

Connection diagram between ECS and AIS

NO.	DATE	REVISION & DESCRIPTION	REVIEWED	CHECKED	SIGNATURE



