



USER MANUAL

PORTABLE VHF TELEPHONE

Alpha 40s

GENERAL INFORMATION

I. Copyright

The entire contents of this user manual, including any future updates, revisions, and modifications, shall remain the property of NSR at all times. Unauthorized copies or reproduction of this manual, either in part or whole, in any form of print and electronic media, is prohibited. The contents herein can only be used for the intended purpose of this manual.

II. Disclaimer

NSR is devoted to publishing and maintaining this user manual. As we continue to improve our products to satisfy customers' needs, the information in this document is subject to change without prior notice. NSR does not make any representations or warranties (implied or otherwise) regarding the accuracy and completeness of this document and shall in no event be liable for any loss of profit or any commercial damage, including but not limited to special, incidental, consequential, or other damage.

III. Safety Warning



DON'T DISASSEMBLE THE EQUIPMENT

Access to the interior of the Alpha 40s should only be by a NSR certified technician.

IV. Product Category

This product is categorized as "portable" in accordance with the requirements as defined in IEC 60945.

V. Hardware / Software Version

Part Name	Part Type	S/W Version
Transceiver	Alpha 40s	V1.XX
Rechargeable battery	NBT800CN	

VI. Disposal Instruction

Local regulations should be followed when batteries are disposed of in order to protect your environment.

MODIFY RECORD

No.	Modify by	Date	Paragraph	Version	Reason
1	Q/A	2023/04/28		01	First edition
2	Q/A	2023/07/25	All	02	General modification
3	Q/A	2025/03/18	3, Appendix	03	Channel list addition, etc.

TABLE OF CONTENTS

1. OVERVIEW	5
2. PRODUCT DESCRIPTION	6
2.1 Product Composition.....	6
2.2 Description of Components.....	6
2.3 Display on LCD Panel.....	8
3. SPECIFICATIONS	9
4. GENERAL OPERATION	10
4.1 Power ON/OFF	10
4.2 Channel Selection	10
4.3 SNR (Squelch) Level Adjustment.....	10
4.4 Transmission.....	11
4.5 Reception.....	11
4.6 Monitor Function	12
4.7 Volume Level Adjustment.....	12
4.8 Dual Watch Function.....	12
4.9 Channel Scan Function.....	13
4.10 Keyboard Lock Function	13
5. MENU OPERATIONS	14
5.1 Channel Setting.....	14
5.1.1 TX Power.....	14
5.1.2 TX Enable.....	15
5.1.3 Priority Channel.....	15
5.1.4 Call Channel.....	15
5.1.5 Scan Add	16
5.2 Channel Info.....	16
5.3 Radio Setting	17
5.3.1 Beep	17
5.3.2 Contrast.....	17
5.3.3 Backlight.....	18
5.3.4 Key Locker.....	18
5.3.5 Power Save Function	19

5.3.6	Vox Level	19
5.3.7	Vox Delay	20
5.3.8	Tx Timeout.....	20
5.3.9	Scan Type.....	21
5.3.10	Dual Watch	21
5.3.10.1	Dual Watch Type	21
5.3.10.2	Dual Watch Timer	22
5.3.10.3	Dual Watch CH	22
5.3.11	Language.....	22
5.4	Radio Information.....	23
6.	ADVANCED SETTING.....	24
6.1	Channel Group Setting.....	24
6.2	Factory Setting	24
7.	BATTERY & CHARGER	26
7.1	Install the Battery	26
7.2	Remove the Battery	26
7.3	Rechargeable Battery (NBT800CN).....	27
7.4	Charger	27
7.4.1	Specifications	27
7.4.2	Charging the Battery.....	27
7.4.3	Fast Charging	28
7.4.4	Install the Charger	28
8.	MAINTENANCE.....	29
APPENDIX 1	CHANNEL TABLES.....	30
APPENDIX 2	SIZE DRAWINGS.....	42

1. OVERVIEW

Alpha 40s is a marine professional walkie-talkie. It is designed for onboard communication on VHF channels.

Alpha 40s includes ITU, USA, CAN channels, etc. Frequency ranges between 156.000MHz and 163.425MHz.

Alpha 40s conforms to the regulations of IMO MSC.1/Circ.1460/Rev.5 and IEC 60945 etc.

The main features of Alpha 40s are:

- Easy-to-use. Capable of being brought and operated easily by unskilled personnel.
- Compact and rugged construction.
- Watertight design for marine use.
- Full ITU channels, including 4-digit channels.

WARNING

- DO NOT store or place the phone in direct sunlight or in areas with temperatures below -20°C or above +55°C.
- KEEP the phone at least 1 meter away from your vessel's magnetic navigation compass.
- BE CAREFUL, the phone is watertight in design. However, once the phone has been dropped, waterproof protection cannot be guaranteed because of possible damage to the phone's case or the waterproof seal.
- MAKE SURE the antenna and battery are securely attached to the transceiver, and that antenna and battery are dry before attachment. Exposing the inside of the phone to water will result in serious damage to the transceiver.

2. PRODUCT DESCRIPTION







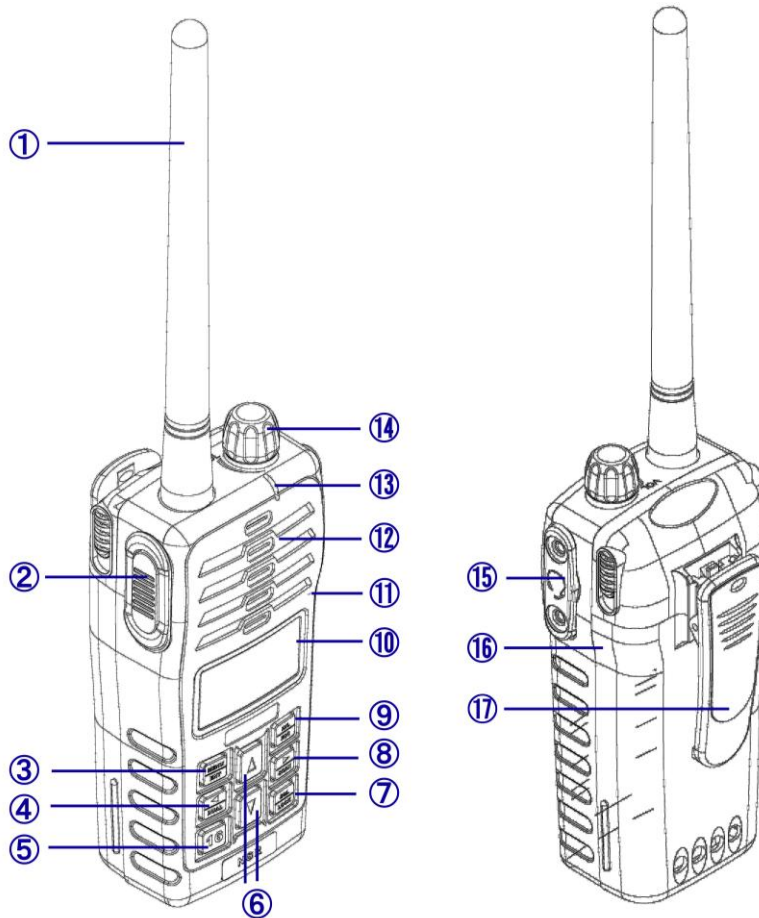

2.1 Product Composition

Standard Equipment List of Alpha 40s:

No.	Item	Type	Q'ty	Part No.
1	Transceiver & Antenna	Alpha 40s	1	N991680
2	Rechargeable battery	NBT800CN	1	
3	Charger	NBT800CU	1	
4	AC/DC adaptor	NBT200CUA	1	
5	Belt clip		1	
6	Waist rope		1	
7	User manual		1	

2.2 Description of Components



No.	Item	Description
①	Antenna	TX/RX antenna.
②	 PTT key	Press to transmit.
③	 [MENU]/ [ENT] key	[MENU]: Press to enter the main menu. [ENT]: Confirm the selection or enter the sub-menu.
④	 [◀]/[DUAL] key	[◀]: Press to decrease the value in some setting menu. [DUAL]: Press to enter or exit the Dual Watch mode.
⑤	 CH 16 key	- Press the key to change to channel 16 immediately. - Hold the key for 1 second to switch to the call channel. - Hold the key to enter the Advanced menu while power on.
⑥	 Up/Down key	Used to move up or down. - Press to change the channel or select an alternative. - While in any Set mode, press to select the setting or value of an item. - Press to change the scanning direction during a scan.
⑦	 [SQL]/[LOCK] key	[SQL]: Press shortly to adjust the SNR (squelch) level in turn. [LOCK]: Press 1.5s to lock the keyboard, and press 1.5s again to unlock it.
⑧	 [▶]/[SCAN] key	[▶]: Press to increase the value in some setting menu. [SCAN]: Press to start or stop the channel scan. Press 1.5s to quickly add or cancel the scan setting for the channel.
⑨	 [H/L]/[ESC] key	[H/L]: Press shortly to select the high or low output power. Hold for 1.5 seconds to manually open the squelch and activate the Monitor function. Press again to stop the monitor. [ESC]: Back to the upper menu, exit the main menu.
⑩	LCD	Indicates channel number, the current status of the battery, selected function, TX/RX/Monitor status, etc.
⑪	Microphone	When transmitting, the microphone shall be positioned at the distance of 5~7cm from your mouth.
⑫	Speaker	Loudspeaker.
⑬	LED (TX/RX indicator)	Indicate transmitting/receiving status by color in red and green correspondingly.
⑭	Power On / Off and Volume Control Knob	Used as ON/OFF switch. When power has been turned ON, it can be used for adjusting a sound level.
⑮	 Jack for Mic/Headset	External Mic/Headset can be connected via this jack. If this has been connected, the internal microphone and speaker are muted. Note: Tighten the cover while no external Mic/Headset, to avoid water.
⑯	Battery	Rechargeable.
⑰	Belt Clip	Detachable.

2.3 Display on LCD Panel

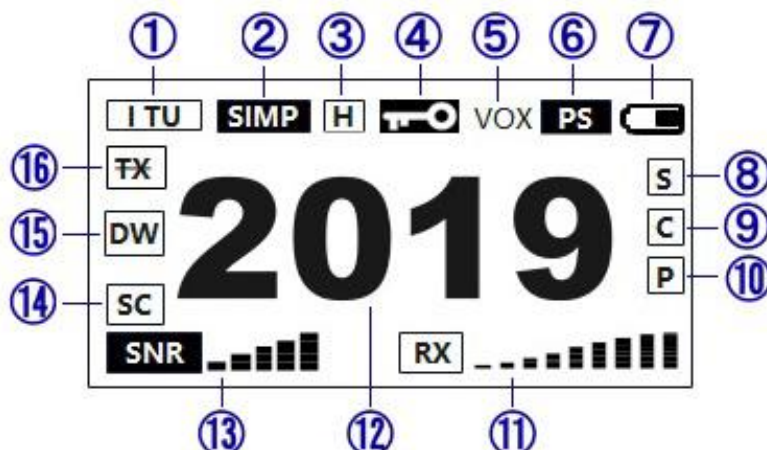

No.	Item	Description
①	ITU / USA / CAN ...	Shows which channel group such as ITU/USA/CAN is selected. (The following sections take ITU as an example)
②	SIMP / DUP-	SIMP: Simplex channel, DUP-: Duplex channel.
③	H / L	Transmitting Output (TX) Power – H (3W), L (1W).
④		Appears while the keyboard lock function is activated.
⑤	VOX	Appears while VOX (Voice operated exchange) function is activated.
⑥	PS	Appears while Power Safe function is activated.
⑦		Battery Level Indicator.
⑧	S	Appears when the channel is added to the scan group.
⑨	C	Appears when the channel is set as the call channel.
⑩	P	Appears when the channel is set as a priority channel.
⑪		Receiving status indicator, appears while receiving the signal.
		Transmitting status indicator, appears while transmitting.
		Appears while the Monitor function is activated.
⑫	2019 (for example)	Indicates the selected operating channel number (for example, 2019).
⑬	SNR	Shows the SNR (squellch) level.
⑭	SC	Blinks while in Scan mode. Refer to paragraph 4.9.
⑮	DW	Blinks while in Dual Watch mode. Refer to paragraph 4.8.
⑯	TX	Appears when TX is disabled.

3. SPECIFICATIONS

- **Frequency range:** 156.000 ~ 161.450 MHz (TX)
156.000 ~ 163.425 MHz (RX)
- **Output Power:** HIGH 3W / LOW 1W
- **Communication Methods:** Simplex
- **Usable Channels:** ITU, USA, CAN, IWW Channels
- **Channel Space:** 25kHz
- **Receive Sensitivity:** $\leq 0.22 \mu\text{V}$
- **Battery Voltage:** 7.4V (DC)
- **Battery Capacity:** 2600 mAh
- **Operating Temperature:** -20°C ~ + 55°C
- **Dimension:** 60.8 (W) × 44.7 (D) × 277.5 (H) mm
- **Weight:** Transceiver + Antenna + Rechargeable Battery + Belt Clip : 305g

4. GENERAL OPERATION

4.1 Power ON/OFF

- **Power ON**

Turn the Power ON/OFF & Volume Control knob clockwise to switch ON the equipment and the latest established status including channel number and usable battery capacity will be displayed on the initial screen in a few seconds.

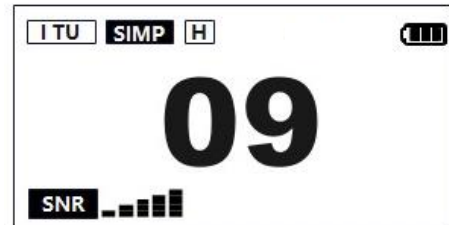

- **Power OFF**



Turn the Power ON/OFF & Volume Control knob counterclockwise to switch the power OFF.

Now, if you switch ON it again, the latest used channel number, channel mode, SNR level, output power level and other established menu items will be loaded automatically.

4.2 Channel Selection

To establish the desired channel number, use  or  key on the front of the equipment.

Press and hold on  or  key to change channel numbers one by one quickly.



Pressing  key via the highest channel number will make a move to the lowest channel number and pressing  key via the lowest channel number will make a move to the highest channel number.

Press  key on the front of the equipment to establish Ch.16 instantly. It also could be established through general channel selection.

Attention: *The channel group (ITU, USA, CAN, 19CHs, etc.) can be selected in Advanced menu by pressing  key while powered on. Please refer to Section 6.*

4.3 SNR (Squelch) Level Adjustment

Press  key located on the right of the front of the equipment. The squelch level is ready to be adjusted.

Select a desired squelch level by pressing  key continuously or using  /  key. Then display will return to the initial screen.

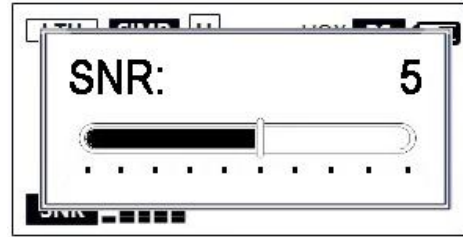



Attention:

1. *If the above keys are not been pressed consequently, the value on the display will be established as a squelch level automatically and then the status of the initial screen will be returned.*
2. *Value of squelch level has been established as 8 by default.*



4.4 Transmission

① Press  key to select TX power. You can also set the TX power in the menu operation. Please refer to Section 5.1.1.

- Choose low power ( appears) for short-range communications; choose high power ( appears) for long-distance communications.
- Some channels are for low power communication only.

② To transmit on the current channel in receiving or standby mode, press  (PTT) key on the left side of the equipment and communicate simultaneously by positioning the microphone near to your mouth.

Release  (PTT) key to stop transmitting and return to receiving or standby mode.

By pressing  (PTT) key for transmission of signal, TX/RX indicator will be lit up with red color on the upper right of the front, and “ - - - ■” will appear on the screen.

4.5 Reception



- ① Adjust the volume levels. Please refer to Section 4.7.
- ② Set the squelch levels. Please refer to Section 4.3.
- ③ To receive communication from other people via currently established channel doesn't need to press any key.

If any signal has been detected, TX/RX indicator will be lit up with green color, “ - - - ■” will appear and audio will be heard from the speaker.

Attention: *Receiving is impossible with PTT key pressed.*

4.6 Monitor Function

The monitor function opens the squelch to monitor useful signal.

Hold  key for 1.5 seconds to manually open the squelch and activate the Monitor function, “” appears. TX/RX indicator will be lit up with green color and the noise will be loud while the monitor function is activated. The squelch stays open until any key is pressed.



4.7 Volume Level Adjustment

To adjust the volume of receiving sound, turn the Power ON/OFF & Volume Control knob in a desired direction.

Turn it clockwise to raise a receiving sound and turn it counterclockwise to reduce it.



Attention: *Turning to the maximum in counterclockwise direction will reduce a receiving sound and can make power off.*

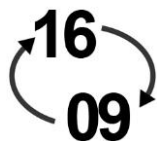

4.8 Dual Watch Function

This function allows one of the receiving Ch.16/CALL CH/ PRIORITY CH together with currently using channel simultaneously.

For example:



Press  key to enter the Dual Watch mode, 

blinks. Press the keys (expect PTT /  /  key) to exit.

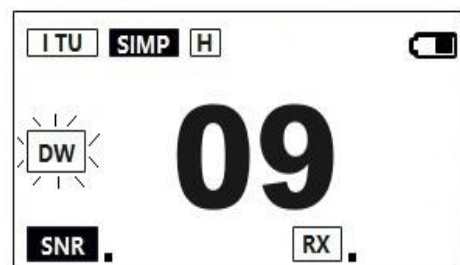





Attention: *Dual watch channel has been set to ch16 by default. Please refer to Section 5.3.10.3.*

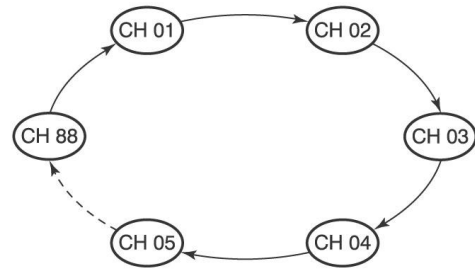

4.9 Channel Scan Function

Channel Scan is an efficient way to locate signals quickly over a wide frequency range. It searches through all scan channels in sequence. However, Ch.16 is not checked unless it is set as a Scan channel.

When a signal is received, the scan pauses until the signal disappears, or resumes after pausing 5 seconds, or stops, depending on the set mode setting. Please refer to Section 5.3.9.





Press  key to start or stop the channel scan.  blinks during scanning. You can also press other keys (expect PTT /  /  key) to stop the scan.

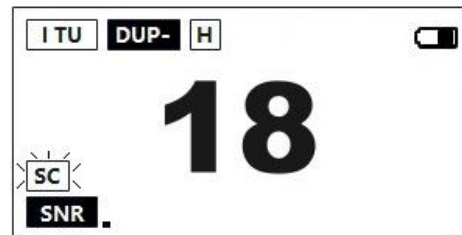

Press  or  key to change the scanning direction or manually resume the scan.





Set Scan channels before the scan. You can also cancel Scan channels not need to be scanned. Please refer to Section 5.1.5.

4.10 Keyboard Lock Function

This function electronically locks all keys (except  (PTT) and  (LOCK) keys) to prevent accidental changing of the channel and function access.

- ① Press and hold  key for 1.5 seconds to turn the function ON. A notice shows the keyboard is locked, then  appears on the top of the front of the equipment. If you press other keys during the keyboard lock function is activated, a notice will display as right.



- ② Press and hold  key for 1.5 seconds to turn the function OFF. A notice shows the keyboard is unlocked and  disappears.

You can also set the keyboard switch by menu operation. Please refer to Section 5.3.4.

Attention: *Even if key locking has been established, the PTT key is activated.*

5. MENU OPERATIONS

Press  key on the front of the equipment, then [MENU] screen appears. It includes [Channel Set], [Channel Info], [Radio Set] and [Radio Info] items.

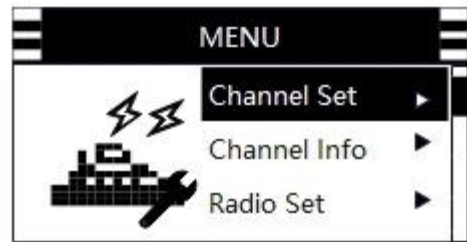

5.1 Channel Setting

Move the cursor to [Channel Set] item, and press  key, then [CHANNEL SET] screen appears. It includes [Tx Power], [Tx Enable], [Priority CH], [Call CH] and [Scan Add] items.

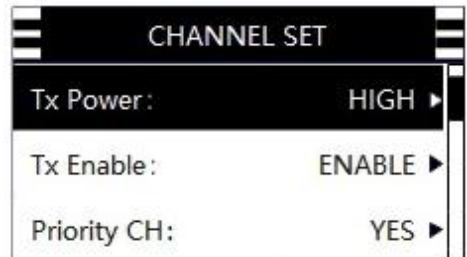

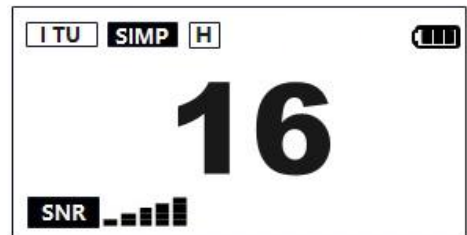

5.1.1 TX Power

- First of all, ensure which power level has been established in the receiving mode. The High is displayed as .



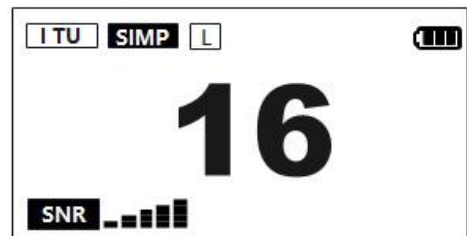

- The Low is displayed as .



- To change current power level of the channel, move the cursor to [TX POWER] item, then press  key to enter into the [TX POWER] menu.



- Press  or  key and then press 

key to select a desired power level (with  displayed) . Press  key to exit.

Attention: Channel 15, 17, 75 and 76 is fixed at L (1W).

5.1.2 TX Enable

- **TX** appears when TX is disabled.
- To change TX status, move the cursor to [**Tx Enable**] item, then press key to enter into the [**TX ENABLE**] menu.
- Press or key and then press key to select TX enabled or disabled (with ✓ displayed) . Press key to exit.

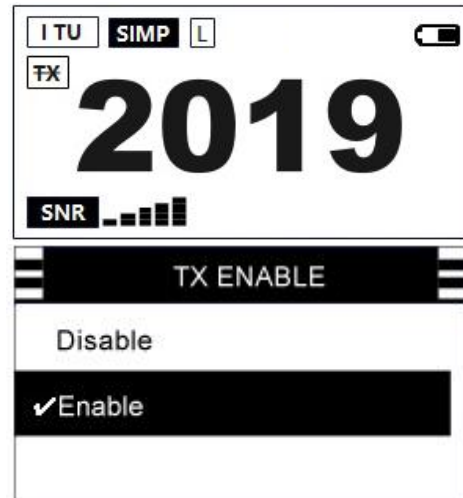

Attention: *Transmission is prohibited on Channel 2019, 2020, 2078 and 2079.*

5.1.3 Priority Channel

- **P** appears when the channel is set as a priority channel.
- To set the priority channel, move the cursor to [**Priority CH**] item, then press key to enter into the [**PRIORITY CH**] menu.
- Press or key and then press key to set the priority channel or not (with ✓ displayed) . Press key to exit.



5.1.4 Call Channel

The call channel normally defaults to Channel 9. You can program the call channel with your most often-used channel in each channel group for quick recall.

- **C** appears when the channel is set as a call channel.

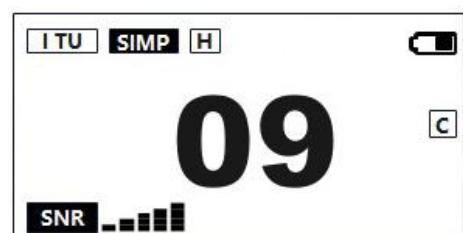

- To set the call channel, move the cursor to **[Call CH]** item, then press key to enter into the **[CALL CH]** menu.
- Press or key and then press key to set the call channel or not (with displayed) . Press key to exit.



5.1.5 Scan Add

- appears when the channel is set as a scan channel.
- To set the scan channel, move the cursor to **[Scan Add]** item, then press key to enter into the **[SCAN ADD]** menu.
- Press or key and then press key to add or delete as a scan channel (with displayed) . Press key to exit.

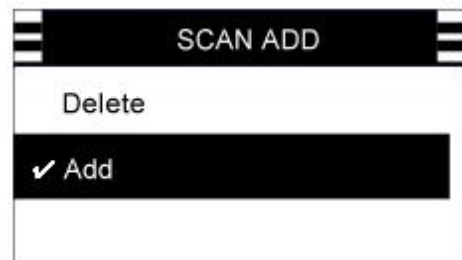
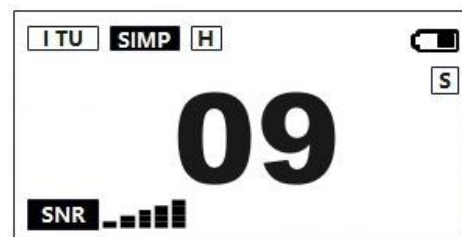

Attention: You can also press key on the initial screen for 1.5s to add /delete the current channel as a scan channel, a related notice will display as right (for example).



5.2 Channel Info

Move the cursor to **[Channel Info]** item, and press key, then **[CHANNEL INFO]** screen appears. You can check the summary information of

the current channel, including **[TX Freq]**, **[RX Freq]**, **[TX Power]**, **[TX Enable]**, **[D JP Mode]**, **[SCAN Add]** and **[CH Type]** items.

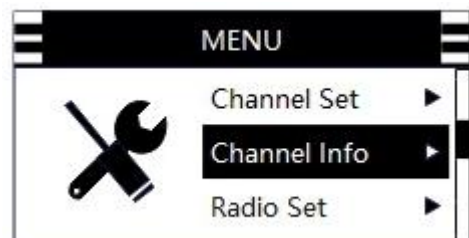

For example, TX Freq: 156.450MHz (CH09).

Press or key to check all other items of the channel.



5.3 Radio Setting

Move the cursor to [Radio Set] item, and press



key, then [RADIO SET] screen appears.

It includes [Beep], [Contrast], [Backlight], [Key Locker], [Power Save], [Vox Level], [Vox Delay], [Tx Timeout], [Scan], [Dual Watch] and [Language] items.



5.3.1 Beep

This function is established to generate or mute audible tone when any key except the PTT key is pressed.

- To set the beep, move the cursor to [Beep] item, then press key to enter into the [BEEP ENABLE] menu.
- Press or key and then press key to set the beep On or Off (with displayed) . Press key to exit.

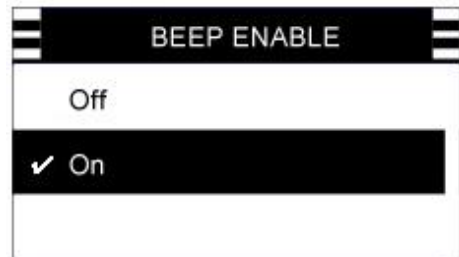

Attention: *Beep mode has been set to On by default.*

5.3.2 Contrast

Set the LCD contrast level among level 0~ Level 9.

- To set the contrast, move the cursor to [Contrast] item, then press key to enter into the [CONTRAST] menu.
- Press arrow keys (/ or /

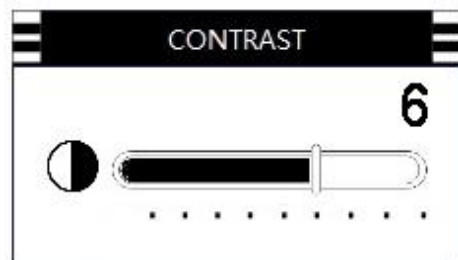

) to adjust the contrast level. Press key to exit.

5.3.3 Backlight

- To set the backlight of the LCD and keyboard, move the cursor to [**Backlight**] item,

then press key to enter into the [**BACKLIGHT SWITCH**] menu.

- Press or key and then press key to set the backlight switch On, Off or Auto

(with displayed). Press key to exit.

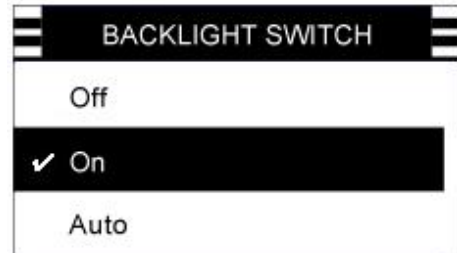

On: Backlight is always ON.

Off: Backlight is always OFF.

Auto: This function is convenient for nighttime operation. The backlight is automatically turned OFF after 5 sec. of inactivity. Press any key to turn the backlight ON.

5.3.4 Key Locker

- To set the status of the key locker, move the cursor to [**Key Locker**] item, then press

key to enter into the [**KEY LOCKER SWITCH**] menu.

- Press or key and then press key to set the key locker switch On, Off or Auto

(with displayed). Press key to exit.

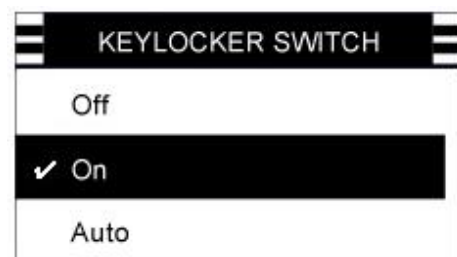

On: While the key locker switch is set as On, you

can lock the keyboard by key. Please refer to Section 4.10.

Off: While the key locker switch is set as Off, the lock function by key is disabled.

Auto: While the key locker switch is set as Auto, all keys excluding the PTT key, will be automatically locked about 15s after the last operation. A note will also appear at the same time, as shown on the right. Then the menu screen will return to the initial screen.

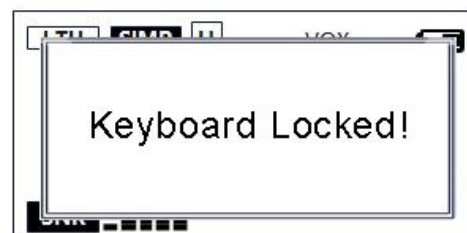





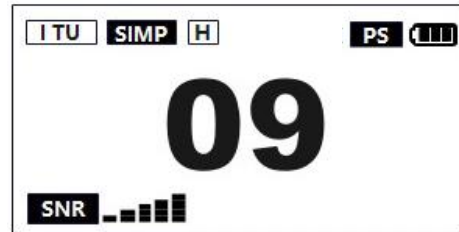

5.3.5 Power Save Function

This function enables to extend the usable time of the battery by decreasing the power consumption in unnecessary devices. The establishment of the function permits to minimize the activities of running equipment so that it could manage the required power for each built-in device effectively.

- **PS** appears when the power save function is set as On.



- To set the power save function, move the cursor to **[Power Save]** item, then press  key to enter into the **[PS SWITCH]** menu.

- Press  or  key and then press  key to turn the function On or Off (with  displayed) . Press  key to exit.

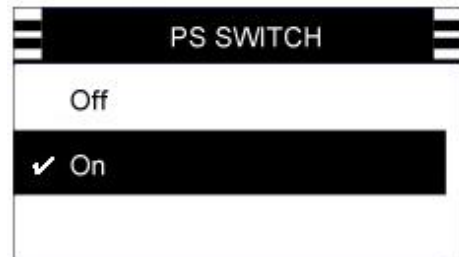

5.3.6 Vox Level

The VOX voice control function allows you to make a call without pressing PTT key when transmitting. If the function is activated, when you start talking, the transmitter will automatically turn on and turn off when there is no any sound.

Because the VOX function is activated by sound, it can also pick up background noise and start transmitting. To avoid unnecessary transmitting, you can set the voice sensitivity level to activate the transmitting only if the sound level reaches this value.

Please turn the VOX function on and off depending on the environment. Normally, it is recommended to press the PTT key for transmitting.

- **VOX** appears when the VOX function is set as On.
- To set the VOX function, move the cursor to **[Vox Level]** item, then press  key to enter into the **[VOX LEVEL]** menu.



- Press or key and then press key to turn the function OFF or ON (set as Level 1 ~ Level 10) (with ✓ displayed). Press key to exit.



5.3.7 Vox Delay

When people speak, they naturally pause briefly between words. The VOX delay ensures that the transmitting is not closed during the typical short pause of voice communication while the VOX function is activated. Thus effectively avoid missing some voice messages.

- To set VOX delay, move the cursor to [**Vox Delay**] item, then press key to enter into the [**VOX DELAY**] menu.

- Press or key and then press key to set the desired delay among 0.5s, 1.0s, 1.5s, 2.0s, 2.5s and 3.0s (with ✓ displayed). Press key to exit.



5.3.8 Tx Timeout







This function is to limit the transmitting time, thus avoid damage to the radio caused by long time transmitting.

- To set TX timeout, move the cursor to [**Tx Timeout**] item, then press key to enter into the [**TX TIMEOUT**] menu.

- Press or key and then press key to set the timeout OFF or among 60s, 120s, 180s, 240s and 300s (with ✓ displayed) . Press key to exit.



5.3.9 Scan Type

- To set the scan type, move the cursor to [**Scan**] item, then press  key to enter into the [**SCAN**] menu.
- Press  key to enter into the [**SCAN TYPE**] menu.
- Press  or  key and then press  key to set the desired scan type among TO, CO and SE (with ✓ displayed). Press  key to exit.

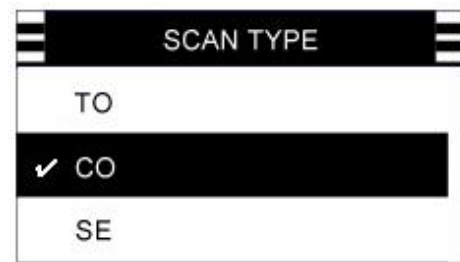
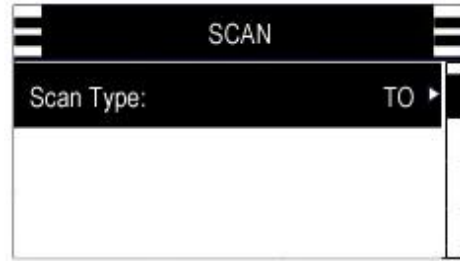





TO: Time Scan. When a signal is received, the scan resumes after pausing 5 seconds.
CO: Carrier Scan. When a signal is received, the scan pauses until the signal disappears.
SE: Search Scan. When a signal is received, the scan stops.

5.3.10 Dual Watch

To set dual watch items, move the cursor to [**Dual Watch**] item, then press  key to enter into the [**DUAL WATCH**] menu. It includes [**D_Watch Type**], [**D_Watch Timer**] and [**D_Watch CH**] items.



5.3.10.1 Dual Watch Type





- To set dual watch type, move the cursor to [**D_Watch Type**] item, then press  key. Press  key to enter into the [**D_WATCH TYPE**] menu.
- Press  or  key and then press  key to set the desired dual watch type



among TO (Time), CO (Carrier) and SE (Search) (with ✓ displayed). Press  key to exit.

5.3.10.2 Dual Watch Timer





- To set the dual watch timer (interval time between each watch), move the cursor to **[D_Watch Timer]** item, then press  key to enter into the **[D_WATCH TIMER]** menu.

- Press  or  key and then press  key to set the desired dual watch type among 2S~10S (with ✓ displayed). Press  key to exit.



5.3.10.3 Dual Watch CH

- To set the dual watch channel, move the cursor to **[D_Watch CH]** item, then press  key to enter into the **[D_WATCH CH]** menu.

- Press  or  key and then press  key to set the desired dual watch channel among 16 CH, CALL CH and PRIORITY CH (with ✓ displayed). Press  key to exit.







5.3.11 Language

The default menu language is English.

- To change the menu language, move the cursor to **[Language]** item, then press  key to enter into the **[LANGUAGE]** menu.



- Press  or  key and then press  key to set the desired language (with  displayed). Press  key to exit.



5.4 Radio Information

Move the cursor to [**Radio Info**] item, and press



key, then [**RADIO INFO**] screen appears.

You can check the summary information of the radio, including items such as [**Radio Group**], [**Freq Range**], [**Serial Number**], [**FW Version**], [**FW Build Date**] and [**FW Build Time**]. For example, Radio Group: ITU.

Press  or  key to check all other items of the radio.



6. ADVANCED SETTING

Press and hold **16** key to enter the [Advanced] menu while power on. It includes [CH Group Set] and [Factory Set] items.



6.1 Channel Group Setting

The Operating Channels include ITU, USA, CAN, etc. Frequency ranges between 156.000MHz and 163.425MHz.





- To select a channel group, move the cursor to [① CH Group Set] item, then press

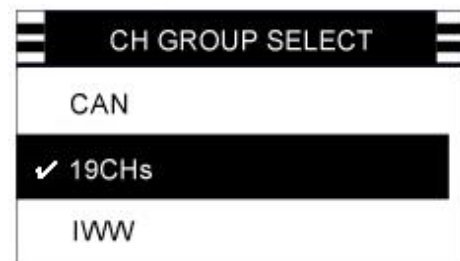

key, the [CH GROUP SET] screen appears.



- Press  key again, the [CH GROUP SELECT] screen appears. It includes items such as [ITU], [RUS], [USA], [CAN], [19CHs], [IWW] and [PRV].

- Press  or  key and then press  key to set the desired channel group (with ✓ displayed). Press  key to exit.

Attention: *The default setting for the channel group is ITU.*





6.2 Factory Setting

[Factory Set] is to return the system to the factory default setting.

- Move the cursor to [② Factory Set] item, and

press  key, then [FACTORY SET] screen appears. It includes items such as [ITU Group Reset], [RUS Group Reset], [USA Group Reset], [CAN Group Reset], [19CH Group Reset], [IWW Group Reset], [PRV Group Reset], [ALL Group Reset], [Parameter Reset] and [ALL Reset].



- Press  or  key and then press  key to set the desired item. A notice screen appears, then press  key to confirm the operation. Press  key (NO) to exit.

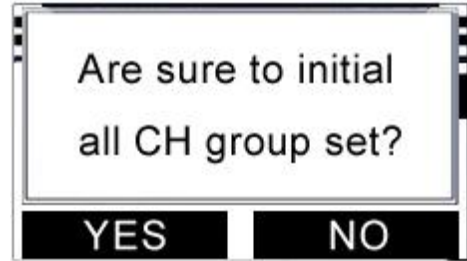

Attention: You can press  key until the screen is back to the initial one.

7. BATTERY & CHARGER

7.1 Install the Battery

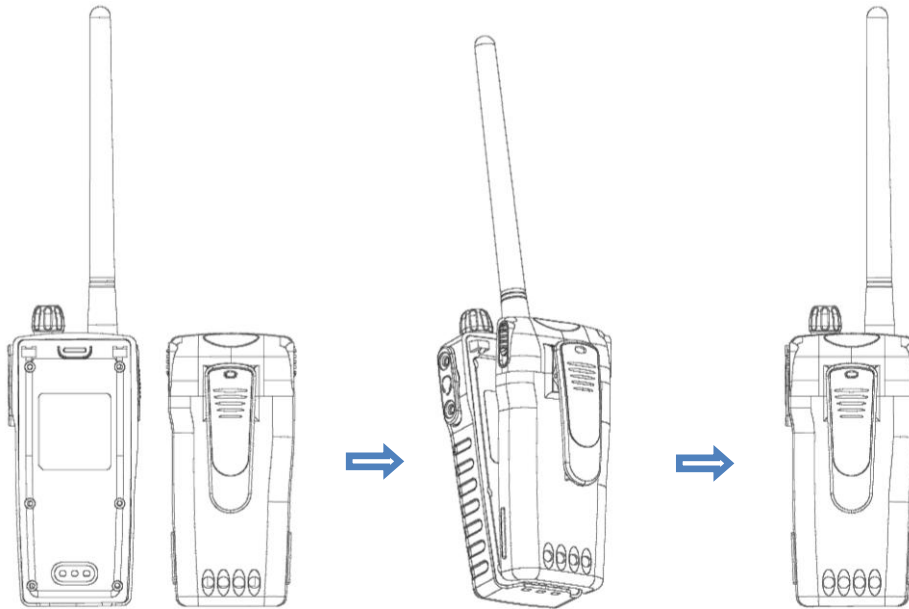

- Place the battery into the transceiver to fit the bottom slot and attach the battery securely.
- Push the battery upside in position until the latch comes back to the locked position.

7.2 Remove the Battery

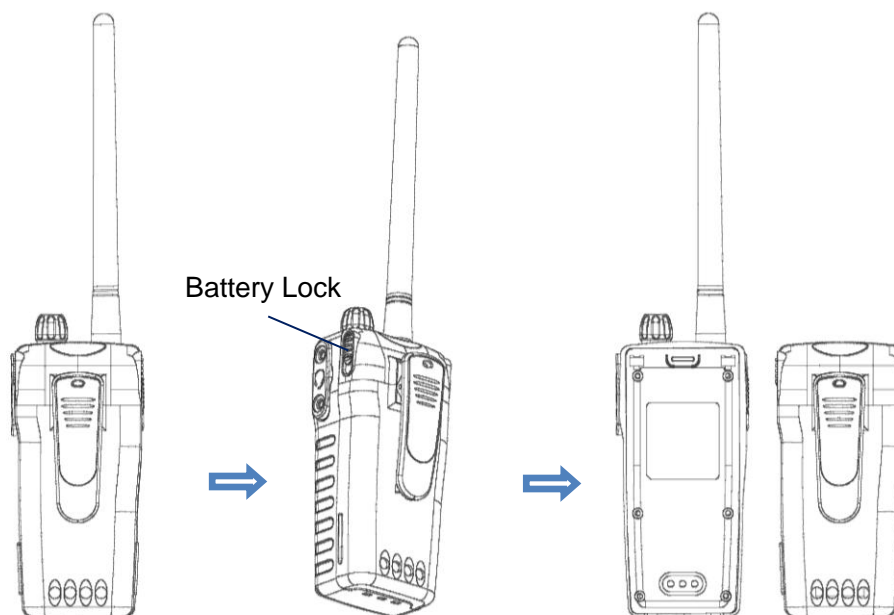

- Press down the black battery locks on both sides of the battery.
- After the latch is released, remove the battery.

Attention:

1. *The battery cannot be easily removed if the black battery locks are not pressed enough to release.*
2. *Do not shortcut the battery or throw it into fire.*
3. *Do not disassemble the battery case by yourself.*

7.3 Rechargeable Battery (NBT800CN)

The rechargeable battery used for Alpha 40s is a fast-charging battery with stability and high reliability.

The battery should be fully charged before use for the best capacity and safe operation.

Don't charge the battery with the charger not supplied by NSR because the battery is designed to use only the dedicative charger of the manufacturer.

If the battery is assembled with a transceiver, it should be charged when the transceiver is powered off.

Capacity for the rechargeable battery is 2600mAh.

7.4 Charger

7.4.1 Specifications

- Input voltage: DC 12V/1A
- Charging time: Around 160 minutes
- Operating temperature: 0°C ~ +40°C
- Charging current: 850mA (± 10%)

7.4.2 Charging the Battery

The charger can be used to charge the batteries in three ways:

- Only one battery;
- Only one battery assembled with the transceiver;
- One battery and the other battery assembled with the transceiver together.

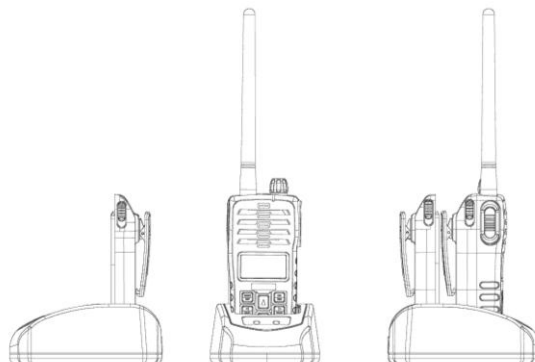

The charging status can be identified from the LED indicator as below:

*** Charger LED indicator**

Red LED	Charging
Green LED	Fully charged
Yellow LED	Charging pending or battery overheating
Red LED is blinked	Battery malfunction or pre-charging mode

Two LEDs, FRONT and REAR, will indicate the charging status for two batteries respectively.

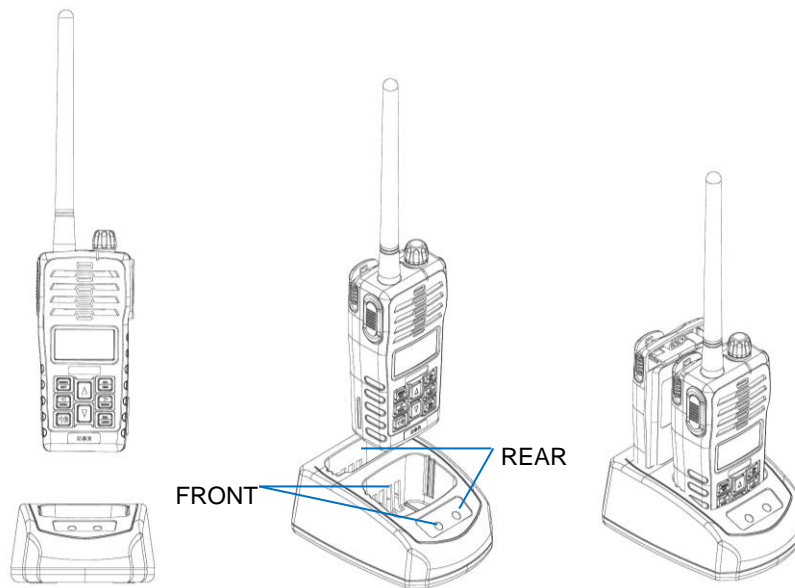

7.4.3 Fast Charging

In case the batteries are fully discharged, the charger goes into Pre-Charge Mode, in which the LED indicator blinks in red.

Leave the fully-discharged battery to be charged for ten minutes until the normal voltage has arrived. Then release the battery from the charger and put it back. The charger enters Fast-Charge Mode, and the LED indicator stays red instead of blinking.

7.4.4 Install the Charger

The charger can be mounted on the table.
Fix the charger on the table with two screws supplied.

Note: The two holes at the bottom of the charger are covered by the sticker, but the screws can pass through easily, so you needn't remove the sticker when installing.



8. MAINTENANCE

The below troubleshooting table provides common symptoms of troubles and means to rectify them. Even if it is impossible to restore with normal operation, don't attempt to check inside the equipment. Any repairs should be done by a qualified technician.

SYMPTOM	INSPECTION
Can't turn on the power	<ul style="list-style-type: none"> ● Confirm that the battery has been assembled in its place properly. ● Separate the battery from the transceiver to ensure that the contact plane not to be wetted or covered with dust. If the contact plane between the battery and transceiver is wetted or covered with dust, clean and dry it with a piece of cloth. ● Ensure whether the battery has been discharged completely. The battery could be charged through the battery charger. ● Ensure that the knob of Power On/Off & Volume Control knob has been turned correctly. ● Contact the manufacturer or its authorized dealer for service.
No sound from the speaker.	<ul style="list-style-type: none"> ● The squelch level is too high. Set the squelch level to the threshold level. ● The volume level is too low. Adjust the volume level to a suitable level.

APPENDIX 1 CHANNEL TABLES

ITU VHF Channel Table (REV.WRC-19 Appendix18)

Channel designator	Notes	Transmitting frequencies (MHz)		Inter- ship	Port operations and ship movement		Public correspondence
		From ship stations	From coast stations		Single frequency	Two frequency	
60	<i>m)</i>	156.025	160.625		x	x	x
01	<i>m</i>	156.050	160.650		x	x	x
61	<i>m</i>	156.075	160.675		x	x	x
02	<i>m</i>	156.100	160.700		x	x	x
62	<i>m</i>	156.125	160.725		x	x	x
03	<i>m</i>	156.150	160.750		x	x	x
63	<i>m</i>	156.175	160.775		x	x	x
04	<i>m</i>	156.200	160.800		x	x	x
64	<i>m</i>	156.225	160.825		x	x	x
05	<i>m</i>	156.250	160.850		x	x	x
65	<i>m</i>	156.275	160.875		x	x	x
06	<i>f</i>	156.300		x			
2006	<i>r)</i>	160.900	160.900				
66	<i>m</i>	156.325	160.925		x	x	x
07	<i>m</i>	156.350	160.950		x	x	x
67	<i>h</i>	156.375	156.375	x	x		
08		156.400		x			
68		156.425	156.425		x		
09	<i>i</i>	156.450	156.450	x	x		
69		156.475	156.475	x	x		
10	<i>h), q)</i>	156.500	156.500	x	x		
70	<i>f), j)</i>	156.525	156.525	Digital selective calling for distress, safety and calling			
11	<i>q</i>	156.550	156.550		x		
71		156.575	156.575		x		
12		156.600	156.600		x		
72	<i>i</i>	156.625		x			
13	<i>k)</i>	156.650	156.650	x	x		
73	<i>h), i)</i>	156.675	156.675	x	x		
14		156.700	156.700		x		
74		156.725	156.725		x		
15	<i>g</i>	156.750	156.750	x	x		
75	<i>n), s)</i>	156.775	156.775		x		
16	<i>f)</i>	156.800	156.800	DISTRESS, SAFETY AND CALLING			
76	<i>n), s)</i>	156.825	156.825		x		
17	<i>g)</i>	156.850	156.850	x	x		
77		156.875		x			
18	<i>m)</i>	156.900	161.500		x	x	x
78	<i>m)</i>	156.925	161.525		x	x	x
1078		156.925	156.925		x		
2078	<i>mm)</i>		161.525		x		
19	<i>m)</i>	156.950	161.550		x	x	x

Channel designator	Notes	Transmitting frequencies (MHz)		Inter- ship	Port operations and ship movement		Public correspondence
		From ship stations	From coast stations		Single frequency	Two frequency	
1019		156.950	156.950		x		
2019	<i>mm)</i>		161.550		x		
79	<i>m)</i>	156.975	161.575		x	x	x
1079		156.975	156.975		x		
2079	<i>mm)</i>		161.575		x		
20	<i>m)</i>	157.000	161.600		x	x	x
1020		157.000	157.000		x		
2020	<i>mm)</i>		161.600		x		
80	<i>y), wa)</i>	157.025	161.625		x	x	x
21	<i>y), wa)</i>	157.050	161.650		x	x	x
81	<i>y), wa)</i>	157.075	161.675		x	x	x
22	<i>y), wa)</i>	157.100	161.700		x	x	x
82	<i>x), y), wa)</i>	157.125	161.725		x	x	x
23	<i>x), y), wa)</i>	157.150	161.750		x	x	x
83	<i>x), y), wa)</i>	157.175	161.775		x	x	x
24	<i>w), x)</i>	157.200	161.800		x	x	x
1024	<i>w)</i>	157.200	157.200	x (digital only)	x (digital only)		
2024	<i>w)</i>	161.800	161.800	x (digital only)	x (digital only)		
84	<i>w), x)</i>	157.225	161.825		x	x	x
1084	<i>w)</i>	157.225	157.225	x (digital only)	x (digital only)		
2084	<i>w)</i>	161.825	161.825	x (digital only)	x (digital only)		
25	<i>w), x)</i>	157.250	161.850		x	x	x
1025	<i>w)</i>	157.250	157.250	x (digital only)	x (digital only)		
2025	<i>w)</i>	161.850	161.850	x (digital only)	x (digital only)		
85	<i>w), x)</i>	157.275	161.875		x	x	x
1085	<i>w)</i>	157.275	157.275	x (digital only)	x (digital only)		
2085	<i>w)</i>	161.875	161.875	x (digital only)	x (digital only)		
26	<i>w), x)</i>	157.300	161.900		x	x	x
1026	<i>w)</i>	157.300					
2026	<i>w)</i>		161.900				
86	<i>w), x)</i>	157.325	161.925		x	x	x
1086	<i>w)</i>	157.325					
2086	<i>w)</i>		161.925				
1027	<i>zz)</i>	157.350	157.350		x		
ASM 1	<i>z)</i>	161.950	161.950				
87	<i>zz)</i>	157.375	157.375		x		
1028	<i>zz)</i>	157.400	157.400		x		
ASM 2	<i>z)</i>	162.000	162.000				
88	<i>zz)</i>	157.425	157.425		x		
AIS 1	<i>f), l), p)</i>	161.975	161.975				
AIS 2	<i>f), l), p)</i>	162.025	162.025				

Notes referring to the Table

General notes

- a) Administrations may designate frequencies in the inter-ship, port operations and ship movement services for use by light aircraft and helicopters to communicate with ships or participating coast stations in predominantly maritime support operations under the conditions specified in Nos. **51.69, 51.73, 51.74, 51.75, 51.76, 51.77** and **51.78**. However, the use of the channels which are shared with public correspondence shall be subject to prior agreement between interested and affected administrations.
- b) The channels of the present Appendix, with the exception of channels 06, 13, 15, 16, 17, 70, 75 and 76, may also be used for high-speed data and facsimile transmissions, subject to special arrangement between interested and affected administrations.
- c) The channels of the present Appendix, with the exception of channels 06, 13, 15, 16, 17, 70, 75 and 76, may be used for direct-printing telegraphy and data transmission, subject to special arrangement between interested and affected administrations. (WRC-12)
- d) The frequencies in this table may also be used for radiocommunications on inland waterways in accordance with the conditions specified in No. **5.226**.
- e) Administrations may apply 12.5 kHz channel interleaving on a non-interference basis to 25 kHz channels, in accordance with the most recent version of Recommendation ITU-R M.1084, provided:
 - it shall not affect the 25 kHz channels of the present Appendix maritime mobile distress and safety, automatic identification system (AIS), and data exchange frequencies, especially the channels 06, 13, 15, 16, 17, 70, AIS 1 and AIS 2, nor the technical characteristics set forth in Recommendation ITU-R M.489-2 for those channels;
 - implementation of 12.5 kHz channel interleaving and consequential national requirements shall be subject to coordination with affected administrations. (WRC-12)

Specific notes

- f) The frequencies 156.300 MHz (channel 06), 156.525 MHz (channel 70), 156.800 MHz (channel 16), 161.975 MHz (AIS 1) and 162.025 MHz (AIS 2) may also be used by aircraft stations for the purpose of search and rescue operations and other safety-related communication. The frequencies 156.525 MHz (channel 70), 161.975 MHz (AIS 1) and 162.025 MHz (AIS 2) may also be used by autonomous maritime radio devices Group A that enhance the safety of navigation, using digital selective calling and/or AIS technology. Such use should be in accordance with the most recent version of Recommendation ITU-R M.2135. (WRC-19)
- g) Channels 15 and 17 may also be used for on-board communications provided the effective radiated power does not exceed 1 W, and subject to the national regulations of the administration concerned when these channels are used in its territorial waters.
- h) Within the European Maritime Area and in Canada, these frequencies (channels 10, 67, 73) may also be used, if so required, by the individual administrations concerned, for communication between ship stations, aircraft stations and participating land stations engaged in coordinated search and rescue and anti-pollution operations in local areas, under the conditions specified in Nos. **51.69, 51.73, 51.74, 51.75, 51.76, 51.77** and **51.78**.
- i) The preferred first three frequencies for the purpose indicated in Note a) are 156.450 MHz (channel 09), 156.625 MHz (channel 72) and 156.675 MHz (channel 73).
- j) Channel 70 is to be used exclusively for digital selective calling for distress, safety and calling.
- k) Channel 13 is designated for use on a worldwide basis as a navigation safety communication channel, primarily for intership navigation safety communications. It may also be used for the ship movement and port operations service subject to the national regulations of the administrations

- concerned.
- l) These channels (AIS 1 and AIS 2) are used for an automatic identification system (AIS) capable of providing worldwide operation, unless other frequencies are designated on a regional basis for this purpose. Such use should be in accordance with the most recent version of Recommendation ITU-R M.1371. (WRC-07)
 - m) These channels may be operated as single frequency channels, subject to coordination with affected administrations. The following conditions apply for single frequency usage:
 - The lower frequency portion of these channels may be operated as single frequency channels by ship and coast stations.
 - Transmission using the upper frequency portion of these channels is limited to coast stations.
 - If permitted by administrations and specified by national regulations, the upper frequency portion of these channels may be used by ship stations for transmission. All precautions should be taken to avoid harmful interference to channels AIS 1, AIS 2, ASM 1 and ASM 2. (WRC-19)
 - mm) Transmission on these channels is limited to coast stations. If permitted by administrations and specified by national regulations, these channels may be used by ship stations for transmission. All precautions should be taken to avoid harmful interference to channels AIS 1, AIS 2, ASM 1 and ASM 2. (WRC-19)
 - n) With the exception of AIS, the use of these channels (75 and 76) should be restricted to navigation-related communications only and all precautions should be taken to avoid harmful interference to channel 16, by limiting the output power to 1 W. (WRC-12)
 - o) (SUP - WRC-12)
 - p) Additionally, AIS 1 and AIS 2 may be used by the mobile-satellite service (Earth-to-space) for the reception of AIS transmissions from ships. (WRC-07)
 - q) When using these channels (10 and 11), all precautions should be taken to avoid harmful interference to channel 70. (WRC-07)
 - r) In the maritime mobile service, the frequency 160.9 MHz (channel 2006) is designated for autonomous maritime radio devices Group B that do not enhance the safety of navigation, using AIS technology, in accordance with the most recent version of Recommendation ITU-R M.2135. Autonomous maritime radio devices Group B are limited to a transmitter e.i.r.p. of 100 mW and an antenna height not exceeding 1 m above the surface of the sea.
 In the maritime mobile service, this frequency may also be used for experimental use for future applications or systems (e.g. new AIS applications, man over board systems, etc.). If authorized by administrations for experimental use, the operation shall not cause harmful interference to, or claim protection from, stations operating in the fixed and mobile services, including the use of autonomous maritime radio devices Group B. (WRC-19)
 - s) Channels 75 and 76 are also allocated to the mobile-satellite service (Earth-to-space) for the reception of long- range AIS broadcast messages from ships (Message 27; see the most recent version of Recommendation ITU-R M.1371). (WRC-12)
 - t) (SUP – WRC-15)
 - u) (SUP – WRC-15)
 - v) (SUP – WRC-15)
 - w) The frequency bands 157.1875-157.3375 MHz and 161.7875-161.9375 MHz (corresponding to channels: 24, 84, 25, 85, 26, 86, 1024, 1084, 1025, 1085, 1026, 1086, 2024, 2084, 2025, 2085, 2026 and 2086) are identified for the utilization of the VHF Data Exchange System (VDES). The VDES terrestrial and satellite components are described in the most recent version of Recommendation ITU-R M.2092. These channels shall not be used for feeder links. The channels may be merged using multiple 25 kHz contiguous channels to form channel bandwidths of 50, 100

or 150 kHz. The channel usage is shown below:

- The channels 1024, 1084, 1025 and 1085 are identified for ship-to-shore, shore-to-ship and ship-to-ship communications, but ship-to-satellite and satellite-to-ship communications may be possible without imposing constraints on ship-to-shore, shore-to-ship and ship-to-ship communications.
- The channels 2024, 2084, 2025 and 2085 are identified for shore-to-ship and ship-to-ship communications, but ship-to-satellite and satellite-to-ship communications may be possible without imposing constraints on shore- to-ship and ship-to-ship communications.
- The channels 1026, 1086, 2026 and 2086 are identified for ship-to-satellite and satellite-to-ship communications and are not used by the terrestrial component of VDES.
- The channels 24, 84, 25 and 85 are identified for ship-to-shore and shore-to-ship communications.

The Earth-to-space component of the VDES shall not cause harmful interference to, nor claim protection from, nor restrict future development of, terrestrial systems operating in the same frequency bands.

Until 1 January 2030, the channels 24, 84, 25, 85, 26 and 86 may also be used for analogue modulation described in the most recent version of Recommendation ITU-R M.1084 by an administration that wishes to do so, subject to not causing harmful interference to, or claiming protection from other stations in the maritime mobile service using digitally modulated emissions and subject to coordination with affected administrations. (WRC-19)

wa) In Regions 1 and 3:

The frequency bands 157.0125-157.1125 MHz and 161.6125-161.7125 MHz (corresponding to channels: 80, 21, 81 and 22) are identified for utilization of the digital systems described in the most recent version of Recommendation ITU-R M.1842 using multiple 25 kHz contiguous channels.

The frequency bands 157.1375-157.1875 MHz and 161. 7375-161.7875 MHz (corresponding to channels: 23 and 83) are identified for utilization of the digital systems described in the most recent version of Recommendation ITU-R M.1842 using two 25 kHz contiguous channels. The frequencies 157.125 MHz and 161.725 MHz (corresponding to channel: 82) are identified for the utilization of the digital systems described in the most recent version of Recommendation ITU-R M.1842.

The frequency bands 157.0125-157.1875 MHz and 161.6125-161.7875 MHz (corresponding to channels: 80, 21, 81, 22, 82, 23 and 83) can also be used for analogue modulation described in the most recent version of Recommendation ITU-R M.1084 by an administration that wishes to do so, subject to not claiming protection from other stations in the maritime mobile service using digitally modulated emissions and subject to coordination with affected administrations. (WRC-19))

x) In Angola, Botswana, Eswatini, Lesotho, Madagascar, Malawi, Mauritius, Mozambique, Namibia, Democratic Republic of the Congo, Seychelles, South Africa, Tanzania, Zambia and Zimbabwe, the frequency bands 157.1125-157.3375 and 161.7125-161.9375 MHz (corresponding to channels: 82, 23, 83, 24, 84, 25, 85, 26 and 86) are designated for digitally modulated emissions.

In China, the frequency bands 157.1375-157.3375 and 161.7375-161.9375 MHz (corresponding to channels: 23, 83, 24, 84, 25, 85, 26 and 86) are designated for digitally modulated emissions. (WRC-19)

y) These channels may be operated as single or duplex frequency channels, subject to coordination with affected administrations. (WRC-12)

z) Channels ASM 1 and ASM 2 are used for application specific messages (ASM) as described in the most recent version of Recommendation ITU-R M.2092. (WRC-19)

zz) Channels 1027, 1028, 87 and 88 are used as single-frequency analogue channels for port operation and ship movement. (WRC-19)

Channels in Alpha 40s

ITU Channel Table (According to REV.WRC-19 Appendix18)

CH	TX(MHz)	RX(MHz)	Remark
1	156.050	160.650	
2	156.100	160.700	
3	156.150	160.750	
4	156.200	160.800	
5	156.250	160.850	
6	156.300	156.300	
7	156.350	160.950	
8	156.400	156.400	
9	156.450	156.450	
10	156.500	156.500	
11	156.550	156.550	
12	156.600	156.600	
13	156.650	156.650	
14	156.700	156.700	
15	156.750	156.750	Fixed at 1W
16	156.800	156.800	Distress, Safety and Calling
17	156.850	156.850	Fixed at 1W
18	156.900	161.500	
19	156.950	161.550	
1019	156.950	156.950	
2019	--	161.550	Transmission prohibited
20	157.000	161.600	
1020	157.000	157.000	
2020	--	161.600	Transmission prohibited
21	157.050	161.650	
22	157.100	161.700	
23	157.150	161.750	
24	157.200	161.800	
25	157.250	161.850	
26	157.300	161.900	
1027	157.350	157.350	
1028	157.400	157.400	
60	156.025	160.625	
61	156.075	160.675	
62	156.125	160.725	
63	156.175	160.775	
64	156.225	160.825	
65	156.275	160.875	
66	156.325	160.925	

CH	TX(MHz)	RX(MHz)	Remark
67	156.375	156.375	
68	156.425	156.425	
69	156.475	156.475	
71	156.575	156.575	
72	156.625	156.625	
73	156.675	156.675	
74	56.725	56.725	
75	156.775	156.775	Fixed at 1W
76	156.825	156.825	Fixed at 1W
77	156.875	156.875	
78	156.925	161.525	
1078	156.925	156.925	
2078	--	161.525	Transmission prohibited
79	156.975	161.575	
1079	156.975	156.975	
2079	--	161.575	Transmission prohibited
80	157.025	161.625	
81	157.075	161.675	
82	157.125	161.725	
83	157.175	161.775	
84	157.225	161.825	
85	157.275	161.875	
86	157.325	161.925	
87	157.375	157.375	
88	157.425	157.425	

USA Channel Table (According to FCC 47 CFR Part 80: 80.215, 80.371 and 80.373)

CH	TX(MHz)	RX(MHz)	Remark
1001	156.050	156.050	
1005	156.250	156.250	
6	156.300	156.300	
1007	156.350	156.350	
8	156.400	156.400	
9	156.450	156.450	
10	156.500	156.500	
11	156.550	156.550	
12	156.600	156.600	
13	156.650	156.650	1W default
14	156.700	156.700	
15	-	156.750	Transmission prohibited
16	156.800	156.800	Distress, Safety and Calling
17	156.850	156.850	
1018	156.900	156.900	
1019	156.950	156.950	
20	157.000	161.600	
1020	157.000	157.000	
1022	157.100	157.100	
24	157.200	161.800	
25	157.250	161.850	
26	157.300	161.900	
27	157.350	161.950	
28	157.400	162.000	
1063	156.175	156.175	
1065	156.275	156.275	
1066	156.325	156.325	
67	156.375	156.375	1W default
68	156.425	156.425	
69	156.475	156.475	
71	156.575	156.575	1W default
72	156.625	156.625	
73	156.675	156.675	
74	156.725	156.725	
75	156.775	156.775	Fixed at 1W
76	156.825	156.825	Fixed at 1W
77	156.875	156.875	Fixed at 1W
1078	156.925	156.925	
1079	156.975	156.975	
1080	157.025	157.025	
84	157.225	161.825	
85	157.275	161.875	
86	157.325	161.925	
87	157.375	161.975	
88	157.425	157.425	

CAN Channel Table (According to RAMN-ARNM-2021)

CH	TX(MHz)	RX(MHz)	Remark
1	156.050	160.650	
1001	156.050	156.050	
2	156.100	160.700	
3	156.150	160.750	
4	156.200	160.800	
5	156.250	160.850	
1005	156.250	156.250	
6	156.300	156.300	
7	156.350	160.950	
1007	156.350	156.350	
8	156.400	156.400	
9	156.450	156.450	
10	156.500	156.500	
11	156.550	156.550	
12	156.600	156.600	
13	156.650	156.650	Fixed at 1W
14	156.700	156.700	
15	156.750	156.750	Fixed at 1W
16	156.800	156.800	Distress, Safety and Calling
17	156.850	156.850	Fixed at 1W
18	156.900	161.500	
1018	156.900	156.900	
19	156.950	161.550	
2019	--	161.550	Transmission prohibited
20	157.000	161.600	Fixed at 1W
1020	157.000	157.000	
2020	--	161.600	Transmission prohibited
21	157.050	161.650	
22	157.100	161.700	
23	157.150	161.750	
1023	--	161.750	Transmission prohibited
24	157.200	161.800	
25	157.250	161.850	
26	157.300	161.900	
2026	--	161.900	Transmission prohibited
27	157.350	161.950	
1027	157.350	157.350	
28	157.400	162.000	
60	156.025	160.625	
61	156.075	160.675	
62	156.125	160.725	

CH	TX(MHz)	RX(MHz)	Remark
63	156.175	160.775	
1063	156.175	156.175	
64	156.225	160.825	
65	156.275	160.875	
1065	156.275	156.275	
66	156.325	160.925	
1066	156.325	156.325	
67	156.375	156.375	
68	156.425	156.425	
69	156.475	156.475	
71	156.575	156.575	
73	156.675	156.675	
74	156.725	156.725	
75	156.775	156.775	Fixed at 1W
76	156.825	156.825	Fixed at 1W
77	156.875	156.875	Fixed at 1W
78	156.925	161.525	
1078	156.925	156.925	
2078	--	161.525	Transmission prohibited
79	156.975	161.575	
1079	156.975	156.975	
2079	--	161.575	Transmission prohibited
80	157.025	161.625	
1080	157.025	157.025	
81	157.075	161.675	
82	157.125	161.725	
83	157.175	161.775	
84	157.225	161.825	
85	157.275	161.875	
86	157.325	161.925	
2086	--	161.925	Transmission prohibited
87	157.375	157.375	
88	157.425	157.425	

IWW Channel Table (According to ETSI EN 300 698 V2.2.1)

CH	TX(MHz)	RX(MHz)	Remark
1	156.050	160.650	
2	156.100	160.700	
3	156.150	160.750	
4	156.200	160.800	
5	156.250	160.850	
6	156.300	156.300	Fixed at 1W
7	156.350	160.950	
8	156.400	156.400	Fixed at 1W
9	156.450	156.450	
10	156.500	156.500	
11	156.550	156.550	Fixed at 1W
12	156.600	156.600	Fixed at 1W
13	156.650	156.650	Fixed at 1W
14	156.700	156.700	Fixed at 1W
15	156.750	156.750	Fixed at 1W
16	156.800	156.800	Distress, Safety and Calling
17	156.850	156.850	Fixed at 1W
18	156.900	161.500	
19	156.950	161.550	
1019	156.950	156.950	
2019	-	161.550	Transmission prohibited
20	157.000	161.600	
1020	157.000	157.000	
2020	-	161.600	Transmission prohibited
21	157.050	161.650	
22	157.100	161.700	
23	157.150	161.750	
24	157.200	161.800	
25	157.250	161.850	
26	157.300	161.900	
1027	157.350	157.350	
1028	157.400	157.400	
60	156.025	160.625	
61	156.075	160.675	
62	156.125	160.725	
63	156.175	160.775	
64	156.225	160.825	
65	156.275	160.875	
66	156.325	160.925	
67	156.375	156.375	
68	156.425	156.425	

CH	TX(MHz)	RX(MHz)	Remark
69	156.475	156.475	
71	156.575	156.575	Fixed at 1W
72	156.625	156.625	Fixed at 1W
73	156.675	156.675	
74	156.725	156.725	Fixed at 1W
75	156.775	156.775	Fixed at 1W
76	156.825	156.825	Fixed at 1W
77	156.875	156.875	Fixed at 1W
78	156.925	161.525	
1078	156.925	156.925	
2078	-	161.525	Transmission prohibited
79	156.975	161.575	
1079	156.975	156.975	
2079	-	161.575	Transmission prohibited
80	157.025	161.625	
81	157.075	161.675	
82	157.125	161.725	
83	157.175	161.775	
84	157.225	161.825	
85	157.275	161.875	
86	157.325	161.925	
87	157.375	157.375	
88	157.425	157.425	

APPENDIX 2 SIZE DRAWINGS

NO.	DATE	REVISION & DESCRIPTION	CHECKED SIGNATURE
△			

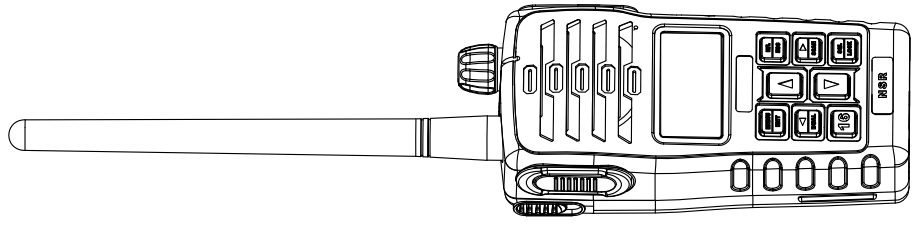

ISO VIEW

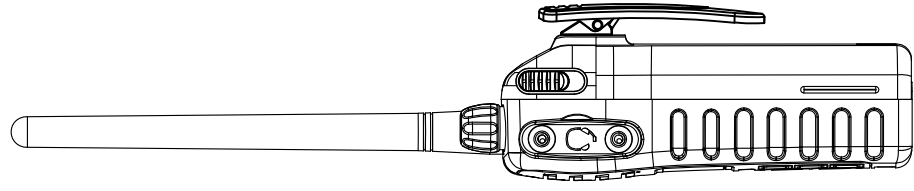

SIDE VIEW

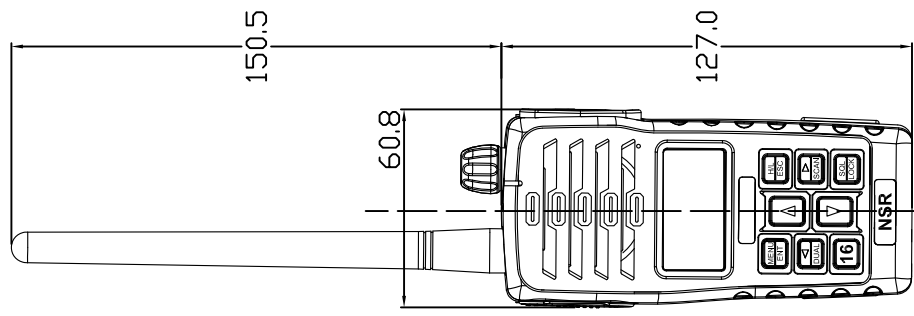

FRONT VIEW

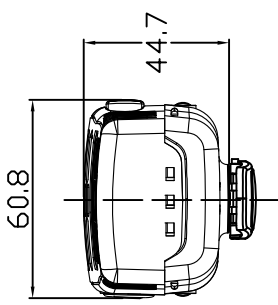

BOTTOM VIEW

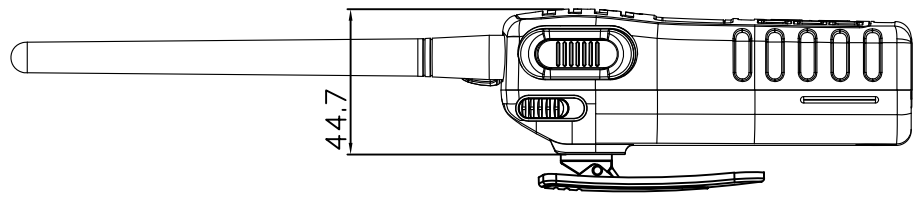

SIDE VIEW

APPLICATION		Alpha 40s PORTABLE VHF TELEPHONE SIZE DRAWING	
DATE	ITEM	SCALE	SIZE
APPROVAL	IN/S	UNIT	LA4
CHECKED	PROJ. PART	DATE	DATE
DRAWING	NO.	DATE	DATE
IMG. NO.	Alpha 40s-ID-001		

NO.	DATE	REVISION & DESCRIPTION	REVIEWED	CHECKED
△			SIGNATURE	

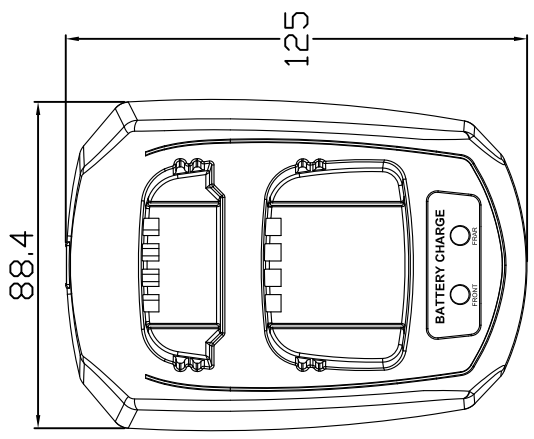

FRONT VIEW

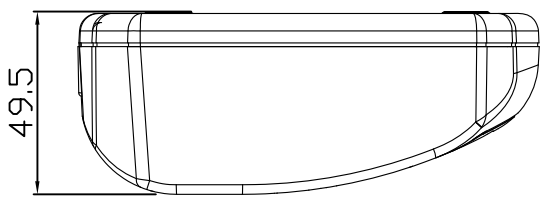

SIDE VIEW

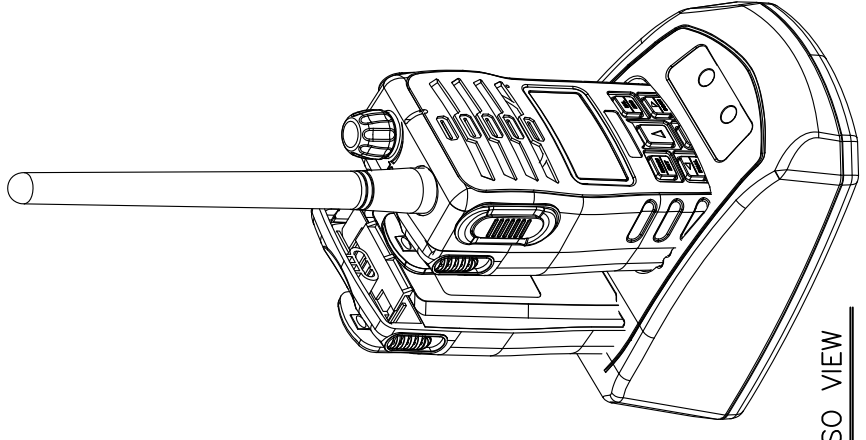

ISO VIEW

NOTE:

- The charger can be used to charge the batteries in three ways:
- Only one battery.
 - Only one battery assembled with the transceiver.
 - One battery and the other battery assembled with the transceiver together.

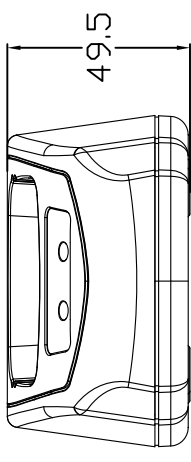

BOTTOM VIEW

APPLICATION		NBT800CU BATTERY CHARGER SIZE DRAWING		
DATE	ITEM	SCALE	UNIT	SIZE
APPROVAL	SCALE	IN/S	MM	A4
CHECKED	PROJ.	SECTION	NO.	VIEWS
DRAWING			NO.	VIEWS
IMG. NO.	Alpha 40s-ID-002			

NEW SUNRISE CO., LTD.
 EST. 1978

Copyright by NEW SUNRISE CO., LTD. (NSR)

www.nsrmarine.com

info@nsrmarine.com

March, 2025